

Digital HD Video Camera Recorder

HXR-MC2000U/MC2000N

Operating Guide

Before operating the unit, please read this manual thoroughly,
and retain it for future reference.

AVCHDHDMI™
HIGH DEFINITION MULTIMEDIA INTERFACEMEMORY STICK™InfoLITHIUM™
SERIESSD™
CLASS 4SD™
XC
CLASS 4

Read this first

Supplied items

The numbers in () are the supplied quantity.

- AC Adaptor (1)
- Power cord (Mains lead) (1)
- A/V connecting cable (1) **A**
- USB cable (1) **B**
- USB Adaptor Cable (1) **C**
- Lens hood (1) **D**
- Eye cup (1) **E**
- Microphone (1) **F**
- Wind screen (1) **G**
- Lens cap (1) **H**
- Rechargeable battery pack NP-F570 (1)
- CD-ROM "Video Camera Application Software" (1)
 - "PMB" (software, including "PMB Help")
- CD-ROM "Manuals for Digital HD Video Camera Recorder" (1)
- "Operating Guide" (2)

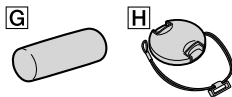
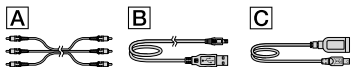

- See page 21 for the memory card you can use with this camcorder.

Using the camcorder

- Do not hold the camcorder by the following parts, and also do not hold the camcorder by the jack covers.

Lens hood

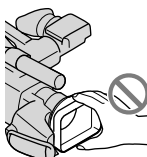

Panel EVF block

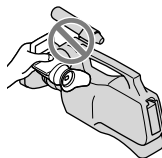

LCD panel

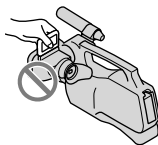

Battery pack



Microphone

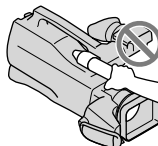

Viewfinder

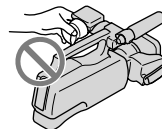

- The camcorder is not dustproofed, dripproofed or waterproofed. See "About handling of your camcorder" (p. 110).

Menu items, LCD panel, viewfinder, and lens

- A menu item that is grayed out is not available under the current recording or playback conditions.

- The LCD screen and the viewfinder are manufactured using extremely high-precision technology, so over 99.99% of the pixels are operational for effective use. However, there may be some tiny black points and/or bright points (white, red, blue, or green in color) that appear constantly on the LCD screen. These points are normal results of the manufacturing process and do not affect the recording in any way.

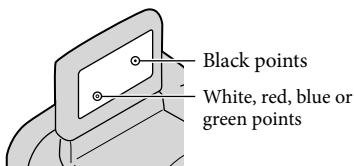

- Exposing the LCD screen, the viewfinder, or the lens to direct sunlight for long periods of time may cause malfunctions.
- Do not aim at the sun. Doing so might cause your camcorder to malfunction. Take images of the sun only in low light conditions, such as at dusk.

About language setting

- The on-screen displays in each local language are used for illustrating the operating procedures. Change the screen language before using the camcorder if necessary (p. 17).

On recording

- To ensure stable operation of the memory card, it is recommended to initialize the memory card with your camcorder before the first use (p. 88). Initializing the memory card will erase all the data stored on it and the data will be irrecoverable. Save your important data on your PC etc.
- Before starting to record, test the recording function to make sure the image and sound are recorded without any problems.
- Compensation for the contents of recordings cannot be provided, even if recording or playback is not possible due to a malfunction of

the camcorder, recording media, etc.

- TV color systems differ depending on the country/region. To view your recordings on a TV, you need a NTSC system-based TV.
- Television programs, films, video tapes, and other materials may be copyrighted. Unauthorized recording of such materials may be contrary to the copyright laws.
- Because of the way that the image device (CMOS sensor) reads out image signals, the following phenomena may occur.
 - The subjects passing by the frame rapidly might appear crooked depending on the recording conditions. (This phenomenon may be notable in displays having high motion resolution.)
 - Horizontal lines appear on the screen during recording under fluorescent lights. The phenomena can be reduced by adjusting the shutter speed (p. 31).

Notes on playing back

- The camcorder is compatible with MPEG-4 AVC/H.264 High Profile for high definition image quality (HD) recording. Therefore, you cannot play back images recorded with high definition image quality (HD) on the camcorder with the following devices;
 - Other AVCHD format compatible devices which are not compatible with High Profile
 - Devices which are not compatible with the AVCHD format
- You may not be able to play back normally images recorded on your camcorder with other devices. Also, you may not be able to play back images recorded on other devices with your camcorder.
- Standard (STD) image quality movies recorded on SD memory cards cannot be played on AV equipment of other manufacturers.

Discs recorded with HD image quality (high definition)

- This camcorder captures high definition footage in the AVCHD format. DVD media containing AVCHD footage should not be used with DVD based players or recorders, as the DVD player/recorder may fail to eject the media and may erase its contents without warning. DVD media containing AVCHD footage may be played on a compatible Blu-ray Disc™ player/recorder or other compatible device.

Save all your recorded image data

- To prevent your image data from being lost, save all your recorded images on external media periodically. It is recommended that you save the image data on a disc such as DVD-R, etc. using your computer. Also, you can save your image data using a VCR, or a DVD/HDD recorder (p. 66).
- You cannot make a AVCHD disc from the image data recorded with **MENU** (MENU) → [Show others] → [REC MODE] (under  [SHOOTING SET] category) set to [HD FX]. Save them on a Blu-ray Disc or using an external media (p. 62, 64).

Notes on battery pack/AC Adaptor

- Be sure to remove the battery pack or the AC Adaptor after turning off the camcorder.
- Disconnect the AC Adaptor from the camcorder, holding both the camcorder and the DC plug.

Note on the camcorder/battery pack temperature

- When the temperature of the camcorder or battery pack becomes extremely high or extremely low, you may not be able to record or play back on the camcorder, due to the protection features of the camcorder being activated in such situations. In this case, an indicator appears on the LCD screen and the viewfinder (p. 99).

When the camcorder is connected to a computer or accessories

- Do not try to format the recording media of the camcorder using a computer. If you do so, your camcorder may not operate correctly.
- When connecting the camcorder to another device with communication cables, be sure to insert the connector plug in the correct way. Pushing the plug forcibly into the terminal will damage the terminal and may result in a malfunction of the camcorder.

If you cannot record/play back images, perform [MEDIA FORMAT]

- If you repeat recording/deleting images for a long time, fragmentation of data occurs on the recording media. Images cannot be saved or recorded. In such a case, save your images on some type of external media first, and then perform [MEDIA FORMAT] by touching **MENU** (MENU) → [Show others] → [MEDIA FORMAT] (under  [MANAGE MEDIA] category) → the desired medium → [YES] → [YES] → **OK**.

Notes on optional accessories

- We recommend using genuine Sony accessories.
- Genuine Sony accessories may not be available in some countries/regions.

About this manual, illustrations and on-screen displays

- The example images used in this manual for illustration purposes are captured using a digital still camera, and therefore may appear different from images and screen indicators that actually appear on your camcorder. And, the illustrations of your camcorder and its screen indication are exaggerated or simplified for understandability.
- In this manual, the internal memory and the memory card are called “recording media.”
- In this manual, the DVD disc recorded with high definition image quality (HD) is called AVCHD disc.
- Design and specifications of your camcorder and accessories are subject to change without notice.

Notes on use



- Do not do any of the following. Otherwise, the recording media may be damaged, recorded images may be impossible to play back or may be lost, or other malfunctions could occur.
 - ejecting the memory card when the access lamp (p. 22) is lit or flashing
 - removing the battery pack or AC Adaptor from the camcorder, or applying mechanical shock or vibration to the camcorder when the  (Movie)/ (Photo) lamps (p. 23) or the access lamp (p. 22) are lit or flashing
- When using a shoulder belt (sold separately), make sure not to crash the camcorder against an object.

Table of contents

| | |
|-----------------------|---|
| Read this first | 2 |
| Notes on use | 5 |

■ Getting started

| | |
|---|----|
| Step 1: Attaching the supplied microphone, eyecup and the lens hood | 10 |
| Attaching the supplied microphone | 10 |
| Attaching the eyecup | 11 |
| Attaching the lens hood | 11 |
| Step 2: Charging the battery pack | 13 |
| Step 3: Turning the power on, and setting the date and time | 16 |
| Changing the language setting | 17 |
| Step 4: Making setting adjustments before recording | 18 |
| The LCD panel | 18 |
| The viewfinder | 18 |
| The shoulder pad | 19 |
| Step 5: Preparing the recording media | 20 |
| Selecting the recording media for movies | 20 |
| Selecting the recording media for photos | 20 |
| Inserting a memory card | 21 |

■ Recording/Playback

| | |
|---|----|
| Recording | 23 |
| Recording movies | 24 |
| Shooting photos | 25 |
| Useful functions for recording movies and photos | 27 |
| Zooming | 27 |
| Recording better images automatically (INTELLIGENT AUTO) | 27 |
| Selecting high definition image quality (HD) or standard image quality (STD) | 28 |
| Selecting the recording mode | 29 |
| Prioritizing the subject | 30 |
| Capturing smiles automatically (Smile Shutter) | 30 |
| Recording high quality photos during movie recording (Dual Rec) | 31 |
| Controlling the image settings manually with the RING | 31 |
| Playback on the camcorder | 33 |

| | |
|---|----|
| Useful functions for playing movies and photos | 36 |
| Searching for desired images by date (Date Index) | 36 |
| Searching for desired scene by pinpoint (Film Roll Index) | 36 |
| Searching for desired scene by face (Face Index) | 36 |
| Playing back a digest of your movies (Highlight Playback) | 37 |
| Using PB zoom with photos | 38 |
| Playing back a series of photos (Slide show) | 39 |
| Playing images on a TV | 40 |
| Connecting to a high definition TV | 40 |
| Connecting to a non-high-definition 16:9 (wide) or 4:3 TV | 42 |

■ Making good use of your camcorder

| | |
|--|----|
| Deleting movies and photos | 44 |
| Protecting recorded movies and photos (Protect) | 45 |
| Dividing a movie | 46 |
| Capturing a photo from a movie | 47 |
| Dubbing/copying movies and photos from the internal memory to memory card | 48 |
| Dubbing movies | 48 |
| Copying photos | 49 |
| Using the Playlist of movies | 50 |
| Creating the Playlist | 50 |
| Playing the Playlist | 51 |









■ Saving movies and photos with a computer

| | |
|---|----|
| Preparing a computer (Windows) | 53 |
| Step 1 Checking the computer system | 53 |
| Step 2 Installing the supplied software "PMB" | 54 |
| Starting PMB (Picture Motion Browser) | 56 |
| Reading "PMB Help" | 56 |
| Selecting the method for creating a disc (computer) | 57 |
| Creating a disc with one touch (One Touch Disc Burn) | 59 |
| Importing movies and photos to a computer | 60 |
| Creating an AVCHD disc | 61 |
| Creating a standard definition image quality (STD) disc that can be played on ordinary DVD players | 63 |

■ Saving images with an external device

| | |
|---|----|
| Saving images in external media (DIRECT COPY)..... | 64 |
| Creating a disc with a DVD writer, recorder..... | 66 |
| Selecting the method for creating a disc..... | 66 |
| Creating a disc with the dedicated DVD writer, DVDirect Express..... | 67 |
| Creating a high definition image quality (HD) disc with a DVD writer, etc., other than DVDirect Express..... | 69 |
| Creating a standard definition image quality (STD) disc with a recorder, etc..... | 70 |

■ Customizing your camcorder

| | |
|--|----|
| Using menus..... | 72 |
| Operating menus..... | 72 |
| Using MY MENU..... | 73 |
| Using the  OPTION MENU..... | 74 |
| Menu lists..... | 75 |
|  MANUAL SETTINGS (Items to adjust for scene condition)..... | 77 |
|  SHOOTING SET (Items for customized shooting)..... | 81 |
|  PHOTO SETTINGS (Items for recording photos)..... | 85 |
|  PLAYBACK (Items for playback)..... | 86 |
|  EDIT (Items for editing)..... | 87 |
|  OTHERS (Items for other settings)..... | 88 |
|  MANAGE MEDIA (Items for recording media)..... | 88 |
|  GENERAL SET (Other setup items)..... | 90 |

■ Additional information

| | |
|--|-----|
| ? Troubleshooting | 93 |
| Self-diagnosis display/Warning indicators | 99 |
| Recording time of movies/number of recordable photos | 103 |
| Expected time of recording and playback with each battery pack | 103 |
| Expected recording time of movies | 103 |
| Expected number of recordable photos | 104 |
| Using your camcorder abroad | 106 |
| Maintenance and precautions | 108 |
| About the AVCHD format | 108 |
| About the memory card | 108 |
| About the "InfoLITHIUM" battery pack | 109 |
| About x.v.Color | 110 |
| About handling of your camcorder | 110 |
| Specifications | 113 |

■ Quick reference

| | |
|--------------------------|-----|
| Screen indicators | 117 |
| Parts and controls | 119 |
| Index | 122 |

Step 1: Attaching the supplied microphone, eyecup and the lens hood

Attaching the supplied microphone

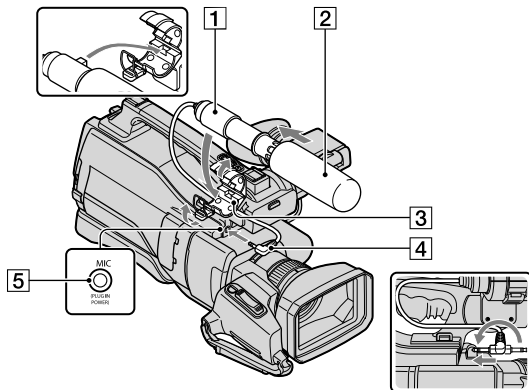

1 Attach the wind screen **2** to the microphone **1**.

2 Unlock the stopper of the microphone holder **3** and open the cover.

3 Align the convex part of the microphone with the concave part of the holder, then place the microphone into the holder. Close the cover and lock the stopper securely.

Be sure to align the ▲ mark on the microphone and the ▮ mark on the holder facing each other.

4 Turn the plug of the microphone counter-clockwise to 180 degrees in the direction of the arrow **4**, and connect it to the Mic jack **5**.

Attaching the eyecup

Attach the eyecup aligned with the eyecup groove in the viewfinder. You can attach the eyecup facing either the right or left side.

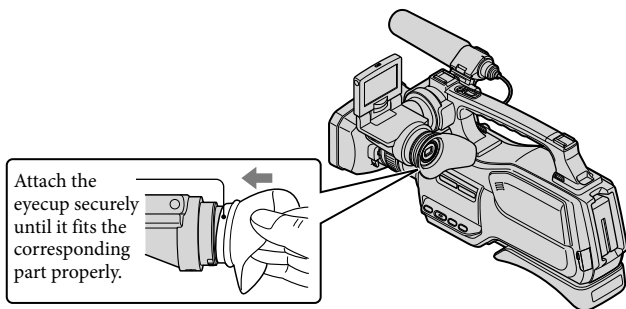

Attaching the lens hood

Align the marks on the lens hood to those on the camcorder, and turn the lens hood in the direction of the arrow.

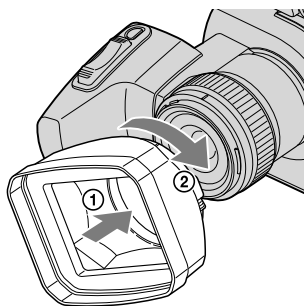

To remove the Lens hood

Turn the lens hood cover in the direction of the arrow as illustrated while pressing the lever on the lens hood cover.

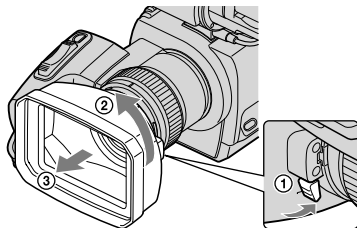

Tips

- If you attach, remove or adjust a 37 mm (1 1/2 in.) PL filter or MC protector, remove the lens hood.

Attaching the lens cap

Attach the lens cap by pressing both knobs on its sides.

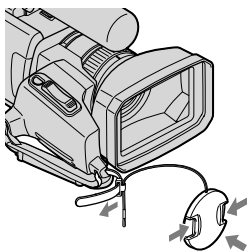

Remove the grip belt and attach the lens cap by leading the grip belt through the attachment on the lens cap string. Then attach the grip belt to the camcorder again.

Step 2: Charging the battery pack

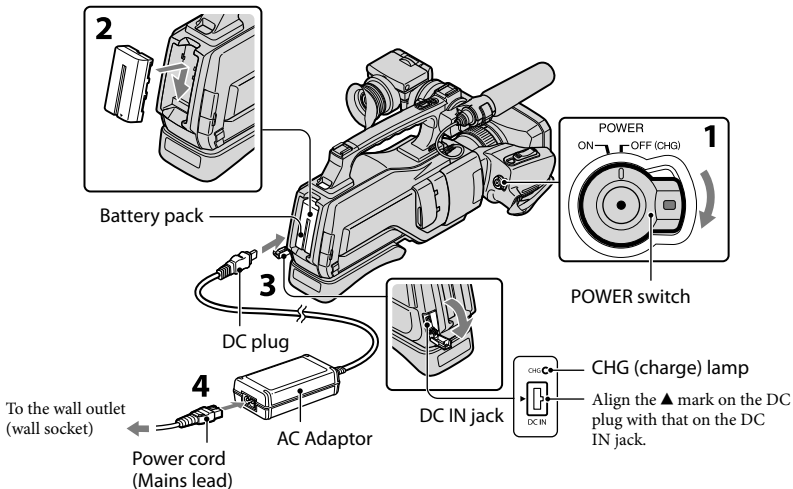

You can charge the “InfoLITHIUM” battery pack (L series) after attaching it to your camcorder.

⚡ Notes

- You cannot attach any “InfoLITHIUM” battery pack other than the L series to your camcorder.

- 1 Slide the POWER switch to OFF (CHG) (the default setting).
- 2 Attach the battery pack to your camcorder.
Attach the battery pack by sliding it in the direction of the arrow while pressing it until it clicks.
- 3 Connect the AC Adaptor to the DC IN jack of your camcorder. Be sure that the ▲ mark on the DC plug is facing to the ▲ mark on your camcorder.
- 4 Connect the AC Adaptor and the power cord (mains lead) to your camcorder and the wall outlet (wall socket).

The CHG (charge) lamp lights up and charging starts. The CHG (charge) lamp turns off when the battery pack is fully charged.

5 When the battery is charged, disconnect the AC Adaptor from the DC IN jack of your camcorder.

Tips

- See page 103 on recording and playing time.
- When your camcorder is on, you can check the approximate amount of remaining battery power with the remaining battery indicator at the upper left on the LCD screen. When the battery power remains 999 minutes or more, [999min] is displayed on the LCD screen.

Charging time

Approximate time (min.) required when you fully charge a fully discharged battery pack.

| Battery pack | Charging time |
|--------------------|---------------|
| NP-F570 (supplied) | 265 |
| NP-F770 | 475 |
| NP-F970 | 645 |

- Times measured with the camcorder at 25 °C (77 °F).
10 °C to 30 °C (50 °F to 86 °F) is recommended.

To remove the battery pack

Slide the POWER switch to OFF (CHG). Push the [BATT (battery) RELEASE] button (①) and remove the battery pack (②).

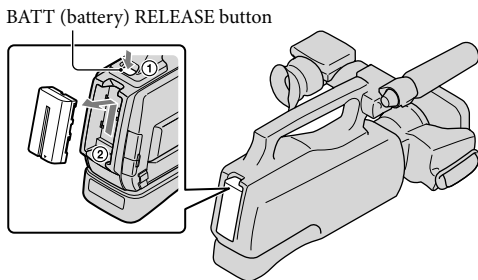

To use a wall outlet (wall socket) as a power source

Make the same connections as “Step 2: Charging the battery pack.” Even if the battery pack is attached, the battery pack is not discharged.



Charging the battery pack abroad

You can charge the battery pack in any countries/regions using the AC Adaptor supplied with your camcorder within the AC 100 V - 240 V, 50 Hz/60 Hz range.

Notes

- Do not use an electronic voltage transformer.

Notes on the battery pack

- When you remove the battery pack or disconnect the AC Adaptor, slide the POWER switch to OFF (CHG) and make sure that the  (Movie)/ (Photo) lamps (p. 23), the access lamp (p. 22) are turned off.
- The CHG (charge) lamp flashes during charging under the following conditions:
 - The battery pack is not attached correctly.
 - The battery pack is damaged.
 - The temperature of the battery pack is low.
Remove the battery pack from your camcorder and put it in a warm place.
 - The temperature of the battery pack is high.
Remove the battery pack from your camcorder and put it in a cool place.

Notes on the AC Adaptor

- Use the nearby wall outlet (wall socket) when using the AC Adaptor. Disconnect the AC Adaptor from the wall outlet (wall socket) immediately if any malfunction occurs while using your camcorder.
- Do not use the AC Adaptor placed in a narrow space, such as between a wall and furniture.
- Do not short-circuit the DC plug of the AC Adaptor or battery terminal with any metallic objects. This may cause a malfunction.

Step 3: Turning the power on, and setting the date and time

- 1 Slide the POWER switch to ON while pressing the green button.

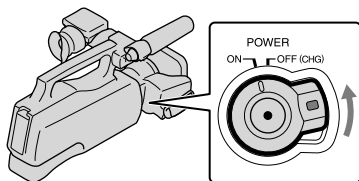

- 2 Select the desired geographical area with / , then touch [NEXT].

Touch the button on the LCD screen

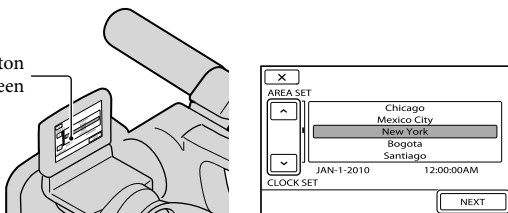

- To set the date and time again, touch (MENU) → [Show others] → [CLOCK/LANG] (under [GENERAL SET] category) → [CLOCK SET]. When an item is not on the screen, touch / until the item appears.



- 3 Set [DST SET] or [SUMMERTIME], date and time, then touch .

The clock starts.

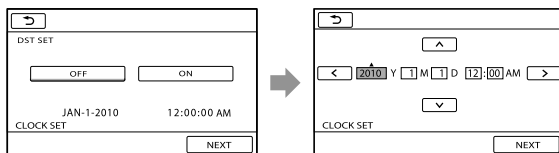
- If you set [DST SET] or [SUMMERTIME] to [ON], the clock advances 1 hour.



⚡ Notes





- The date and time does not appear during recording, but they are automatically recorded on the recording media, and can be displayed during playback. To display the date and time, touch **MENU** (MENU) → [Show others] → [PLAYBACK SET] (under  [PLAYBACK] category) → [DATA CODE] → [DATE/TIME] → **OK** →  → **X**.
- If the button you touch does not react correctly, calibrate the touch panel (p. 111).

To turn off the power

Slide the POWER switch to OFF (CHG).

Changing the language setting

You can change the on-screen displays to show messages in a specified language.

Touch **MENU** (MENU) → [Show others] → [CLOCK/LANG] (under  [GENERAL SET] category) → [LANGUAGE SET] → a desired language → **OK** →  → **X**.

Step 4: Making setting adjustments before recording

The LCD panel

Open the LCD panel (①), then rotate it to the best angle to record or play (②).

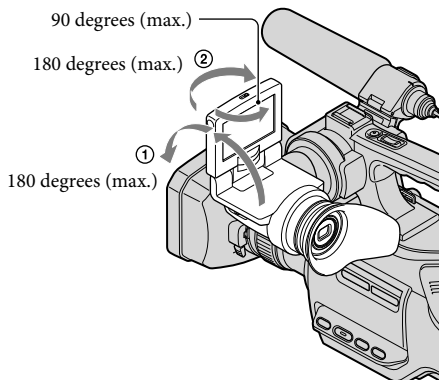

Tips

- If you rotate the LCD panel 180 degrees to the lens side, you can close the LCD panel with the LCD screen facing out. This is convenient during playback operations.
- You can adjust [LCD BRIGHT], [LCD BL LEVEL], [LCD COLOR] by touching **MENU** (MENU) → [Show others] → [SOUND/DISP SET] (under [GENERAL SET] category) (p. 90).

The viewfinder

Pull out the LCD panel block to adjust the position (①), and rotate the viewfinder to the best angle (②).

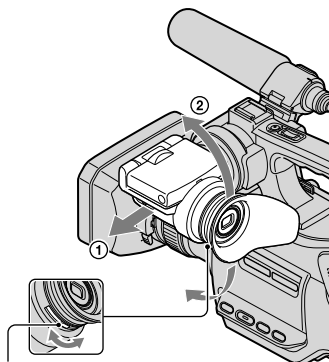

Viewfinder lens adjustment lever
Move it until the picture is clear.

⚡ Notes

- You may see primary colors shimmering in the viewfinder when you move your line of sight. This is not a malfunction. The shimmering colors will not be recorded on the recording media.

💡 Tips

- You can view pictures using the viewfinder to avoid wearing down the battery, or when the picture seen on the LCD screen is poor.

Notes on the LCD/EVF-EVF switch

In the default setting, the switch is set to LCD/EVF.

When you set the switch to LCD/EVF, you can record using the LCD screen whereas you can record using the viewfinder with the LCD screen closed.

When you set the switch to EVF, you can record using only the viewfinder.

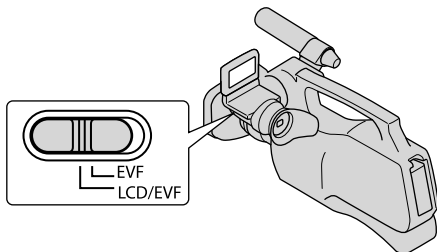

⚡ Notes

- When the LCD/EVF-EVF switch is set to EVF, you cannot operate the touch panel.
- You cannot use LCD and EVF simultaneously.

The shoulder pad

You can adjust the position of the shoulder pad by loosening the screws illustrated below. Tighten the screws again after adjustment.

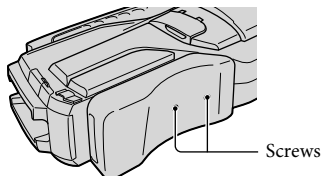

Step 5: Preparing the recording media

The recording media of your camcorder are displayed on the screen as follows.



Internal memory



Memory card

* In the default setting, both movies and photos are recorded on this recording media. You can perform recording, playback and editing operations on the selected medium.

Tips

- See page 103 for the recordable time of movies.
- See page 104 for the number of recordable photos.

Selecting the recording media for movies

- 1 Touch **MENU** (MENU) → [Show others] → [MEDIA SETTINGS] (under  [MANAGE MEDIA] category) → [MOVIE MEDIA SET].

The [MOVIE MEDIA SET] screen appears.

- 2 Touch the desired recording media.

- 3 Touch [YES] → **OK**.

The recording medium is changed.

Selecting the recording media for photos

- 1 Touch **MENU** (MENU) → [Show others] → [MEDIA SETTINGS] (under  [MANAGE MEDIA] category) → [PHOTO MEDIA SET].

The [PHOTO MEDIA SET] screen appears.

- 2 Touch the desired recording media.

- 3 Touch [YES] → **OK**.

The recording medium is changed.

To check the recording media settings

In either movie recording mode or photo recording mode, the media icon of the selected recording media is displayed at the top right corner of the screen.

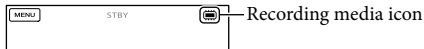

Inserting a memory card

Notes

- Set the recording medium to [MEMORY CARD] to record movies and/or photos on a memory card.

Types of memory card you can use with your camcorder

- Only “Memory Stick PRO Duo” (Mark2) media, “Memory Stick PRO-HG Duo” media, SD memory cards (Class 4 or faster), SDHC memory cards (Class 4 or faster) and SDXC memory cards (Class 4 or faster) can be used with this camcorder. Operation with all memory cards is not assured.
- In this manual, “Memory Stick PRO Duo” (Mark2) media and “Memory Stick PRO-HG Duo” media are called “Memory Stick PRO Duo” media and SD memory cards, SDHC memory cards and SDXC memory cards are called SD cards.
- “Memory Stick PRO Duo” media of up to 32 GB and SD memory cards of up to 64 GB have been tested and proven to operate with your camcorder.

Notes

- MultiMediaCard cannot be used with this camcorder.
- Images recorded on SDXC memory cards cannot be played back or imported on non-exFAT*-compatible computers, AV components, etc., connected to this camcorder by USB cable. Check that the connected devices are compatible with exFAT beforehand. If you connect a device that is not compatible with exFAT, the screen for initialization may appear. Never execute initialization, otherwise all recorded contents will be lost.

* exFAT is the file system used in SDXC memory cards.

Size of memory card you can use with your camcorder

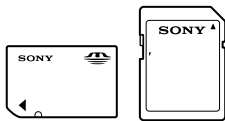

- Only “Memory Stick Duo” media that is about a half the size of the standard “Memory Stick” media, and standard-sized SD memory cards can be used.
- Do not attach a label, etc., to a memory card or memory card adaptor. Doing so may cause a malfunction.

Open the cover, and insert the memory card with the notched edge in the direction as illustrated until it clicks.

- Close the cover after inserting the memory card.

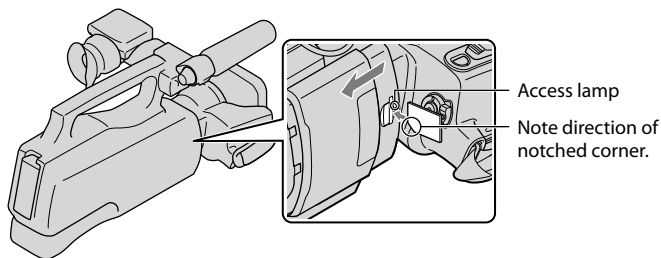

The [Create a new Image Database File.] screen may appear if you insert a new memory card. In that case, touch [YES]. If you record only photos on the memory card, touch [NO].

- Confirm the direction of the memory card. If you forcibly insert the memory card in the wrong direction, the memory card, memory card slot, or image data may be damaged.

⚡ Notes

- If [Failed to create a new Image Database File. It may be possible that there is not enough free space.] is displayed, format the memory card by touching **MENU** (MENU) → [Show others] → [MEDIA FORMAT] (under **MANAGE MEDIA** category) → [MEMORY CARD] → [YES] → [YES] → **OK**.

To eject the memory card

Open the cover and lightly push the memory card in once.

- Do not open the cover during recording.
- When inserting or ejecting the memory card, be careful so that the memory card does not pop out and drop.

Recording

In the default setting, movies and photos are recorded on the internal memory. Movies are recorded with high definition image quality (HD).

Tips

- To change the recording media, see page 20.
- See page 28 when you record images with the standard image quality (STD).

- 1 Remove the lens cap by pressing both knobs on its sides.

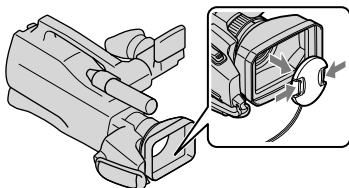

- 2 Slide the POWER switch to ON while pressing the green button.

- You can switch recording modes by pressing MODE. Press MODE to light up the desired recording mode lamp.

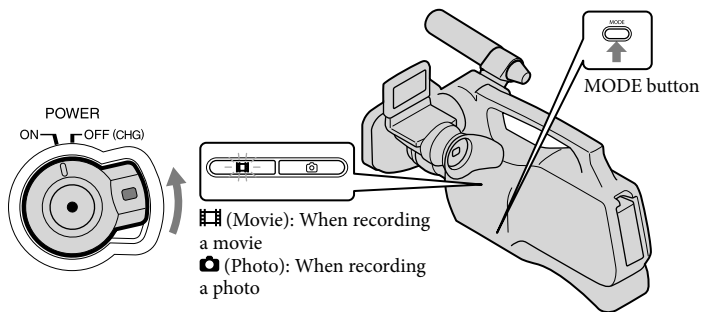

Recording movies

1 Press MODE to light up the (Movie) lamp.

The LCD screen display switches for movie recording mode, and the screen aspect ratio becomes 16:9.

2 Press START/STOP (or).

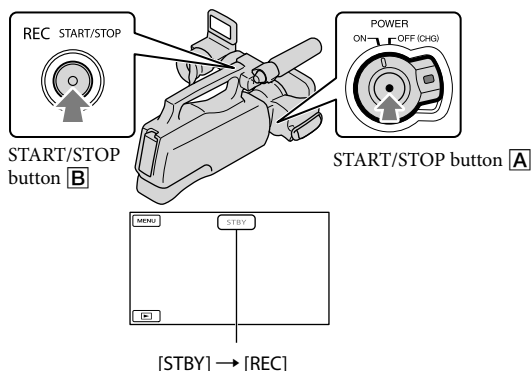

To stop recording, press START/STOP again.

- The icons and indicators on the LCD panel will be displayed for about 3 seconds, then disappear after turning on your camcorder or switching the recording (movie/photo)/playback modes. To display the icons and indicators again, touch anywhere on the screen.

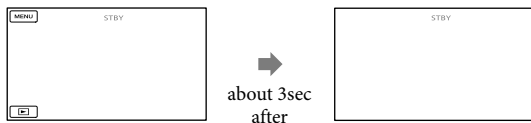

Notes

- The maximum continuous recordable time of movies is about 13 hours.
- When a movie file exceeds 2 GB, the next movie file is created automatically.
- It will take several seconds until you can start recording after you turn on the camcorder. You cannot

operate your camcorder during this time.



- The following states will be indicated if data is still being written onto the recording media after recording has finished. During this time, do not apply shock or vibration to the camcorder, or remove the battery or AC Adaptor.
 - Access lamp (p. 22) is lit or flashing
 - The media icon in the upper right of the LCD screen is flashing

Tips

- See page 103 on the recordable time of movies.
- You can record photos during movie recording by pressing PHOTO fully (Dual Rec, p. 31).
- When a face is detected, a white frame appears and the image quality around the face is optimized automatically ([FACE DETECTION], p. 82).
- You can specify the priority face by touching it (p. 30).
- You can capture photos from recorded movies (p. 47).
- You can check the recordable time, estimated remaining capacity, etc., by touching **MENU** (MENU) → [Show others] → [MEDIA INFO] (under  [MANAGE MEDIA] category).
- The LCD screen of your camcorder can display recording images across the entire screen (full pixel display). However, this may cause slight trimming of the top, bottom, right and left edges of images when played back on a TV which is not compatible with full pixel display. In this case, set [GUIDEFRA] to [ON] (p. 81), and record images using the outer frame displayed on the screen as a guide.
- [STEADYSHOT] is set to [ACTIVE] in the default setting.

Data code during recording

The recording date, time and condition are recorded automatically on the recording media.

They are not displayed during recording. However, you can check them as [DATA CODE] during playback. To display them, touch **MENU** (MENU) → [Show others] → [PLAYBACK SET] (under  [PLAYBACK] category) → [DATA CODE] → a desired setting → **OK** →  → .

Shooting photos

In the default setting, photos are recorded on the internal memory.

Tips

- To change the recording media, see page 20.

1 Press MODE to turn on the (Photo) lamp.

The LCD screen display switches for photo recording mode, and the screen aspect ratio becomes 4:3.

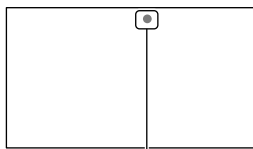
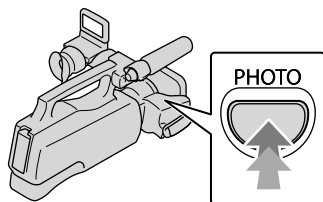

2 Press PHOTO lightly to adjust the focus, then press it fully.



Flashes → Lights up

When  disappears, the photo is recorded.

 Tips

- See page 104 on the recordable number of photos.
- To change the image size, touch **MENU** (MENU) → [Show others] → [ IMAGE SIZE] (under  [PHOTO SETTINGS] category) → a desired setting → **OK** → **X**.
- You cannot record photos while  is displayed.

Useful functions for recording movies and photos

Zooming

You can magnify images up to 17 times the original size with the power zoom lever.

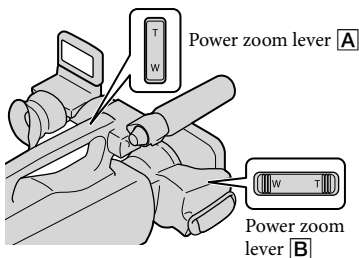

Close view: (Telephoto)

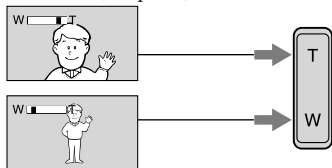

Wider range of view:
(Wide angle)

Move the power zoom lever **B** slightly for a slower zoom. Move it further for a faster zoom.

Notes

- Be sure not to move your finger off the power zoom lever suddenly. The operation sound of the power zoom lever may also be recorded.
- You cannot change the zoom speed of the zoom lever **A** on the handle.
- The minimum possible distance between camcorder and subject while maintaining sharp focus is about 1 cm (about 13/32 in.) for wide angle and about 80 cm (about 31 1/2 in.) for telephoto.
- You can magnify images up to 12 times using optical zooming, unless [E] [STEADYSHOT] is set to [ACTIVE].
- You can also magnify images with [W]/[T] on

the LCD screen by setting [DISPLAY SET] to [AUTO1]. Note, however, that you cannot change the zoom speed with [W]/[T].

Tips

- You can set [E] [DIGITAL ZOOM] (p. 83) if you want to zoom to a greater level.

Recording better images automatically (INTELLIGENT AUTO)

By pressing **AUTO**, you can record images using the INTELLIGENT AUTO function. When you turn the camcorder toward the subject, the camcorder records using the optimum combination of the three detection modes: Face detection, Scene detection and Camera-shake detection. When the camcorder detects the subject, the icons that correspond to the detected condition are displayed.

Tips

- In the default setting, INTELLIGENT AUTO is set to ON.

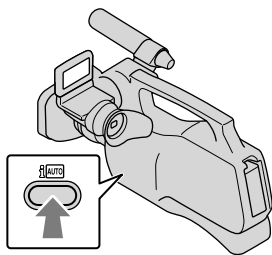

Face detection

Portrait (Baby)

The camcorder detects faces, and adjusts the focus, color, and exposure.

Scene detection

(Backlight), (Landscape), (Twilight), (Spotlight), (Low light), (Macro)

The camcorder selects the most effective setting automatically, depending on the scene.

Camera-shake detection

(Walk), (Tripod)

The camcorder detects whether camera-shake occurs or not, and makes the optimum compensation.

Notes

- The camcorder may not detect the expected scene or subject, depending on the recording conditions.

To cancel INTELLIGENT AUTO

Press .

or the detection mode icons disappear, and you can record with the preferred settings.

Also, the INTELLIGENT AUTO setting is canceled if you change the following settings:

- [SCENE SELECTION]
- [WHITE BAL.]
- [SPOT MTR/FCS]
- [SPOT METER]
- [SPOT FOCUS]
- [EXPOSURE]
- [FOCUS]
- [TELE MACRO]
- [AE SHIFT]
- [WB SHIFT]
- [SMTH SLW REC]
- [STEADYSHOT]
- [LOW LUX]
- [FACE DETECTION]
- [AUTO BACK LIGHT]
- [STEADYSHOT]

- [IRIS]
- [SHUTTER SPEED]
- [PRIORITY SETTING]

Notes

- Above settings are reset to the default settings when INTELLIGENT AUTO is set to ON.

Selecting high definition image quality (HD) or standard image quality (STD)

You can select the desired image quality from the high definition image quality (HD) that enables you to record fine images, or the standard definition image quality (STD) that has more compatibility with various playback devices. Change the image quality according to the recording situation or the playback device.

1 Touch (MENU) → [Show others] → [HD] / [STD] SET] (under [SHOOTING SET] category).

2 Touch [HD QUALITY] to record high definition image quality (HD) images, or touch [STD QUALITY] to record standard definition image quality (STD) images.

3 Touch [YES] → .
Recording image quality is changed.

Tips

- You can record, play, or edit movies in the selected image quality only. To record, play, or edit movies in another image quality, change this setting.



Selecting the recording mode

You can select a recording mode to record the high definition image quality (HD) movies from 4 levels. The recording time of the media is changed depending on recording mode. In the default setting, [ REC MODE] is set to [HD FX].



Long time
recording

High quality
recording



- 1 Touch **MENU** (MENU) → [Show others] → [ REC MODE] (under  [SHOOTING SET] category).

- 2 Touch a desired setting.

If you want to record high quality images with the high definition image quality (HD), select the FX mode. If you want to record longer movies, select the HQ, LP mode.

- 3 Touch **OK** → **X**.

Notes

- You cannot create an AVCHD disc from a movie recorded with [HD FX] mode of [ REC MODE]. Save a movie recorded with [HD FX] mode onto Blu-ray Discs or external storage devices (p. 62, 64).
- You cannot use Dual Rec or the Smile Shutter function when you set [ REC MODE] to [HD FX].

Tips

- Movies are recorded with AVCHD 1920 × 1080/60i format when the FX or FH mode

of the high definition image quality (HD) is selected. And when the HQ or LP mode of the high definition image quality (HD) is selected, movies are recorded with AVCHD 1440 × 1080/60i format. Movies are recorded with MPEG-2 format when the standard image quality (STD) is selected.

- You can select the following high definition image quality (HD) recording mode. “24M” of [HD FX] is the maximum bit-rate, and the value other than of [HD FX], such as “17M,” is an average bit-rate.
 - [HD FX] (AVC HD 24M (FX))
 - [HD FH] (AVC HD 17M (FH)) (the default setting)
 - [HD HQ] (AVC HD 9M (HQ))
 - [HD LP] (AVC HD 5M (LP))
- The recording mode of the standard image quality (STD) is limited to the following value. “9M” is an average bit-rate.
 - [STD HQ] (STD 9M (HQ))
- “M,” such as in “24M,” means “Mbps.”

Prioritizing the subject

When [FACE DETECTION] (p. 82) is set to [ON] (the default setting), and several faces are detected, touch the face you want to record as priority. Focus/color/exposure are adjusted automatically for the selected face. Since the face you touched has priority also with the Smile Shutter function, your camcorder records a photo automatically when it detects the smiling face.



Touch the face you want to record as priority.



The double-lined frame is displayed.

Touch the face with the double-lined frame again to cancel. If you touch another face, the face with the double-lined frame is canceled and the double-lined frame is displayed around the new face.

⚡ Notes

- The face you touched may not be detected, depending on the surrounding brightness or hairstyle of the subject. In this case, touch the face again when you record.

💡 Tips

- If you set [SMILE DETECTION] to [DUAL CAPTURE], or [ALWAYS ON] (p. 83), the face you touch also has priority with the Smile

Shutter function, and your camcorder records a photo automatically when it detects a smile on the prioritized face.

- The double-lined frame around a face targeted for possible smile detection shot turns orange.
- If the face you touched disappears from the LCD screen, the subject selected in [PRIORITY SETTING] (p. 83) has priority. If the face you touched returns to the screen, the face has priority.

Capturing smiles automatically (Smile Shutter)

A photo is recorded automatically when the camcorder detects the smile of a person. An orange frame appears around a face targeted for a possible smile detection shot. In the default setting, the Smile Shutter function is set to [OFF]. When you use the function, change the setting of [SMILE DETECTION] (p. 83).

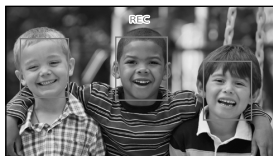

⚡ Notes

- Smiles may not be detected depending on recording conditions, subject conditions, and the setting of your camcorder.
- When [REC MODE] is set to [HD FX], you cannot use the Smile Shutter function.



💡 Tips

- You can select the subject that has priority for face detection and smile detection with [PRIORITY SETTING] (p. 83). When you specify the priority subject by touching the detection frame on the LCD screen, the face with a double-lined frame has priority.
- If a smile is not detected, set the [SMILE SENSITIVITY] (p. 83).



Recording high quality photos during movie recording (Dual Rec)

You can record photos during movie recording by pressing PHOTO.

Notes

-  may appear when the capacity of the recording media is not enough or when you record photos continuously. You cannot record photos while  is displayed.
- When [REC MODE] is set to [HD FX], you cannot use Dual Rec.

Tips

- When the MODE lamp is set to  (Movie), the size of photos becomes [5.3M] (16:9 wide) or [4.0M] (4:3).
- You can record photos during recording standby in the same way as when the  (Photo) lamp is turned on.

Controlling the image settings manually with the RING

It is useful to assign a frequently used menu item to the RING. The following is an example of the procedure when the [FOCUS] setting is assigned (the default setting).

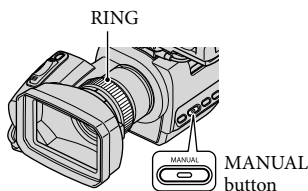

- 1 Press the MANUAL button to activate the manual adjustment mode.

The setting mode switches between

automatic and manual every time you press the MANUAL button.

- 2 Rotate the RING to adjust the focus manually.

Menu items that can be assigned

- [FOCUS] (p. 79)
- [EXPOSURE] (p. 79)
- [IRIS]
Shoots images with the IRIS priority mode. If you adjust the IRIS, you can sharpen the subject with its background blurred or sharpen the whole image.
- [SHUTTER SPEED]
Shoots images with the SHUTTER SPEED priority mode. When you shoot a moving subject at a higher shutter speed, it appears as if frozen on the image. At a lower shutter speed, the subject appears as if it flowing.
- [AE SHIFT] (p. 80)
- [WB SHIFT] (p. 80)

To assign the menu items to the RING

- ① Press and hold the MANUAL button for several seconds.
The [RING SETTING] screen appears.

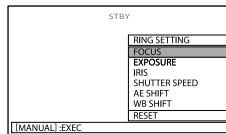

- ② Rotate the RING and select a menu item to be assigned.
- ③ Press the MANUAL button.

⚡ Notes

- You cannot switch the setting of [IRIS] and [SHUTTER SPEED] between automatic and manual by pressing MANUAL during movie recording. Set the automatic or manual mode before starting movie recording.
- The menu item settings done before will be retained even if you set other menu item settings after that. If [EXPOSURE] is set after [AE SHIFT] is set manually, [EXPOSURE] will override [AE SHIFT].
- You cannot set [EXPOSURE], [IRIS], or [SHUTTER SPEED] simultaneously. If you set either one of them, the settings of other 2 items are canceled.
- If you select [RESET] in step ②, all the settings set manually return to the default setting.

💡 Tips

- You can also assign menu items to the RING by touching **MENU** (MENU) → [Show others] → [OTHER REC SET] (under  [SHOOTING SET] category) → [RING SETTING].
- Even if you open the IRIS wider (a smaller F-stop) than F3.4 when you set the zoom lever to the W (Wide angle) side, the IRIS is reset to F3.4 as you move the zoom lever to the T (Telephoto) side.
- If you adjust the IRIS, the in-focus range in front of and behind the focused subject is changed. When you open the IRIS wider (a smaller F-stop), the in-focus range becomes narrower, and when you close the IRIS narrower (a larger F-stop), the in-focus range becomes wider. You can set the IRIS to a preferred value depending on the shooting scenes.
- It is difficult to focus automatically at a lower shutter speed. Manual focusing with your camcorder attached to a tripod is recommended.
- When you record images under a fluorescent lamp, sodium lamp, or mercury lamp, horizontal stripes may appear, flicker may occur, or color may change. In this case, change the shutter speed according to the power supply frequency in your region.

- The displayed camera data differs depending on the settings at the time of recording (p. 86). The icons are shown as follows.

AUTO...Automatic mode

MANUAL...Image brightness manual setting mode

AE A...IRIS priority mode

AE S...SHUTTER SPEED priority mode

Playback on the camcorder

In the default setting, movies and photos that are recorded on the internal memory are played.

Tips

- To change the recording media, see page 20.

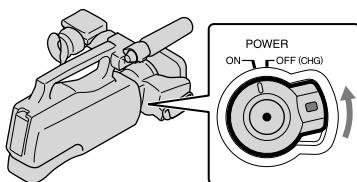

- 1 Slide the POWER switch to ON while pressing the green button.

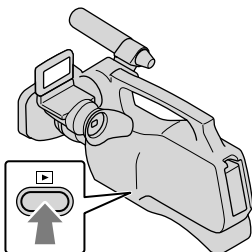

- 2 Press  (VIEW IMAGES).
The VISUAL INDEX screen appears after some seconds.



- You can display the VISUAL INDEX screen also by touching  (VIEW IMAGES) on the LCD screen.
- Images are displayed and sorted by recording date.

- 3 Touch  or  (1) → a desired movie (2) to playback a movie.
Touch the  (Photo) (1) → a desired photo (2) to view a photo.

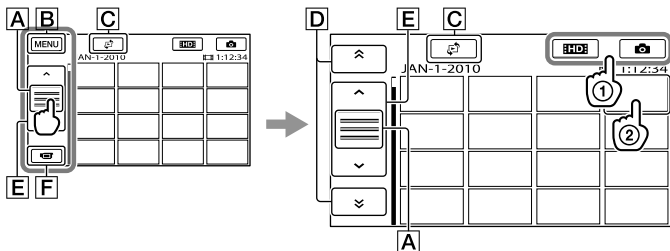

- A** Switches operating button display.
- B** To MENU screen
- C** Displays the screen to select the index type ([DATE INDEX] (p. 36)/[FILM ROLL] (p. 36)/[FACE] (p. 36)).
- D** : Displays images recorded on the previous/next date.*
- E** : Displays the previous/next image.
- F** Returns to the recording screen.

* **D** is displayed when **A** is touched.

- **HSTDB** appears when the standard definition image quality (STD) movie is selected with [**HSTDB**/HSTDBSET] (p. 28).
- You can scroll the display by touching and dragging **D** or **E**.
- appears with the movie or photo that was most recently played or recorded. If you touch the movie or photo with , you can continue playback from the previous time. (appears on the photo recorded on the memory card.)

Playing movies

Your camcorder starts playing the selected movie.

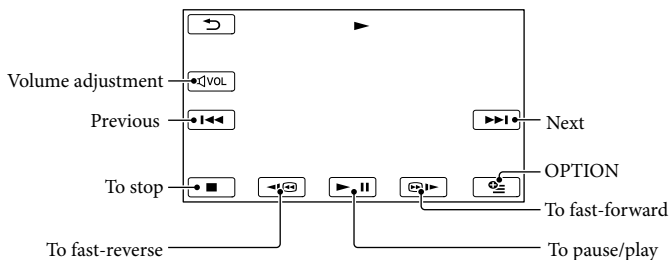

Notes

- You may not be able to play back the images with other devices than camcorder.

Tips

- When playback from the selected movie reaches the last movie, the screen returns to the INDEX screen.
- Touch during pause to play back movies slowly.
- As you repeat touching during playback, movies are played as fast as about 5 times → about 10 times → about 30 times → about 60 times.
- You can also display the VISUAL INDEX by touching **MENU** (MENU) → [Show others] → [VISUAL INDEX] (under [PLAYBACK] category).
- The recording date, time, and shooting conditions are recorded automatically during recording. This information is not displayed during recording, but you can display it during playback by touching

MENU (MENU) → [Show others] → [PLAYBACK SET] (under **[PLAYBACK]** category) → [DATA CODE] → a desired setting → **OK** → **↶** → **✕**.

To adjust the sound volume of movies

While playing back movies, touch **<VOL** → adjust with **🔊** / **🔊+** → **↶**.

- You can also adjust the sound volume by using **—** / **+** from **☰** (OPTION) MENU.

Viewing photos

Your camcorder displays the selected photo.

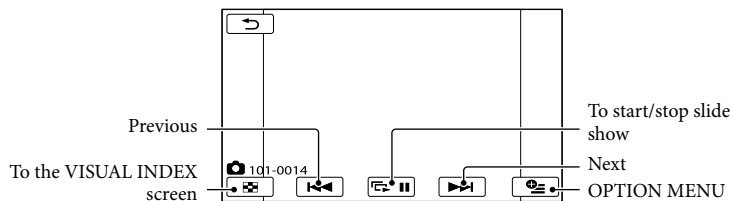

💡 Tips

- When viewing photos recorded on the memory card, **101** (playback folder) appears on the screen.

Useful functions for playing movies and photos

Searching for desired images by date (Date Index)

You can search for desired images by date efficiently.

Notes

- You cannot use the Date Index function for photos on the memory card.

1 Press (VIEW IMAGES).

The VISUAL INDEX screen appears.

2 Touch → [DATE INDEX].

Returns to the VISUAL INDEX screen

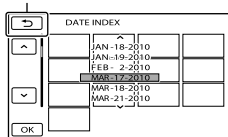

3 Touch / to select the date of the desired image, then touch .

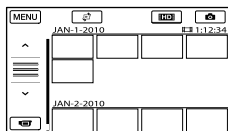

The images of the selected date are displayed on the VISUAL INDEX screen.

Tips

- On the Film Roll Index/Face Index screen, you can display the Date Index by touching the date in the upper right corner of the screen.

Searching for desired scene by pinpoint (Film Roll Index)

Movies can be divided by a set time and the first scene of each division is displayed on the INDEX screen. You can start playing back a movie from the selected thumbnail.

1 Press (VIEW IMAGES).

The VISUAL INDEX screen appears.

2 Touch → [FILM ROLL].

Returns to the VISUAL INDEX screen

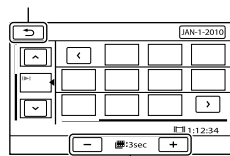

Sets the interval at which to create thumbnails of scenes in a movie.

3 Touch / to select the desired movie.

4 Touch / to search for the desired scene, then touch the scene you want to play back.

Playback starts from the selected scene.

Searching for desired scene by face (Face Index)

The face images detected or touched during movie recording are displayed on the INDEX screen.

You can play back the movie from the selected face image.

1 Press (VIEW IMAGES).

The VISUAL INDEX screen appears.

2 Touch → [FACE].

Returns to the VISUAL INDEX screen

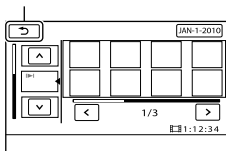

3 Touch / to select the desired movie.

4 Touch / to search for the desired face image, then touch the desired face image to view the scene.

Playback starts from the beginning of the scene with the selected face image.

Notes

- Faces may not be detected depending on recording conditions.
Example: People wearing glasses or hats, or who do not face towards the camera.
- Make sure that you set [FACE DETECTION] to [ON] (p. 82) (the default setting) prior to recording, to search movies on the Face Index.

Playing back a digest of your movies (Highlight Playback)

Your camcorder selects Highlight Playback scenes at random, puts them together, and plays them back as a digest of your high

definition image quality (HD) movies with music and visual effects. Scenes for Highlight Playback differ each time Highlight Playback is selected. You can save the desired Highlight Playback scenario.

Touch (MENU) → [Show others] → [HIGHLIGHT] (under [PLAYBACK] category).

The settings for Highlight Playback appear. The Highlight Playback starts after several seconds.

Returns to the VISUAL INDEX screen

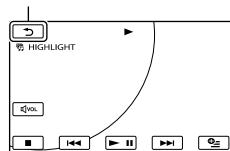

To stop Highlight Playback

To pause, touch .

To stop, touch or .

To change the settings for Highlight Playback

After touching [HIGHLIGHT], touch [HIGHLIGHT SET] before the Highlight Playback starts. You can set following items.

- [PLAYBACK RANGE]
Set the range of movies to be played by selecting the from and to date, then touch .
If no range is set, your camcorder plays the movies starting from those of the date displayed on the VISUAL INDEX screen until the most recently recorded movie.
- [THEME]
Select one of the following: [SIMPLE], [NOSTALGIC], [STYLISH], [ACTIVE] (the default setting)
The music category is selected automatically according to the theme.

- [MUSIC]
From the music category, you can select one or more of the following: [MUSIC1] - [MUSIC4].

- [AUDIO MIX]

The original sound is played back with the music.

Touch **</>** to adjust the balance between the original sound and the music.

- [SHUFFLE]

To play back movies in random order, select [ON].

⚙ Notes

- The [PLAYBACK RANGE] setting is cleared when the Highlight Playback stops.

💡 Tips

- You can change the settings for Highlight Playback during Highlight Playback by touching **☰** (OPTION).
- If you change the settings for Highlight Playback, Highlight Playback scenes are re-selected.
- If you change [MUSIC] after you select [THEME], the music will be selected automatically for the theme from next time.

To save a scenario for Highlight Playback

Touch **☰** (OPTION) → [SCENARIO SAVE] → [YES] during Highlight Playback.

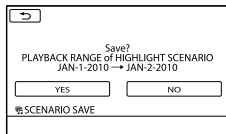

- You can save a maximum of 8 scenarios. If 8 scenarios have already been saved, [HIGHLIGHT SCENARIO full. HIGHLIGHT SCENARIOS may be erased when the SCENARIO ERASE button is pressed.] appears on the LCD screen. Touch [SCENARIO ERASE] to delete unwanted scenarios.

To play back a saved Highlight Playback scenario

Touch **MENU** (MENU) → [Show others] → [SCENARIO] (under [PLAYBACK] category) and select a scenario you want to play back with **</>** and touch **OK**.

⚙ Notes

- If movies included in the Highlight Playback scenario you are going to play are deleted or divided, the scenario is played back with those movies skipped.

To erase the saved Highlight Playback scenario

Touch **MENU** (MENU) → [Show others] → [SCENARIO ERASE] (under [EDIT] category) → [ERASE] and select a scenario you want to erase with **</>**, then touch **OK** → [YES] → **OK** → **X**.

- To erase all scenarios, touch **MENU** (MENU) → [Show others] → [SCENARIO ERASE] (under [EDIT] category) → [ERASE ALL] → [YES] → [YES] → **OK** → **X**.
- You can erase also by touching **☰** (OPTION) during Highlight Scenario Playback or on the scenario selection screen.

Using PB zoom with photos

You can magnify photos from about 1.1 to 5 times the original size.

Magnification can be adjusted with the power zoom lever.

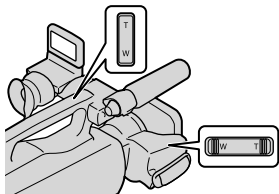

1 Play back the photo you want to magnify.

2 Magnify the photo with T (Telephoto).

The screen is framed.

3 Touch the screen at the point you want to display in the center of the displayed frame.

The point where you touched on the screen is moved to the center of the display frame.

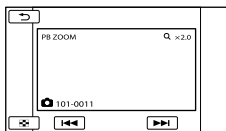

4 Adjust the magnification with W (Wide angle)/T (Telephoto).

To cancel, touch .

Playing back a series of photos (Slide show)

Touch  on the photo playback screen.

The slide show begins from the selected photo.

To stop the slide show

Touch .



To restart the slide show

Touch  again.

Notes

- You cannot operate playback zoom during slide show.

Tips

- You can set continuous slide show playback by selecting  (OPTION) →  tab → [SLIDE SHOW SET] while playing photos. The default setting is [ON] (continuous playback).

Playing images on a TV

Playback image quality depends on the type of TV, or the jacks used to make the connection. Use the supplied AC Adaptor to obtain AC power (p. 14).

Refer also to the instruction manuals supplied with the device to be connected.

Jacks on your camcorder

Open the jack cover and connect the cable.

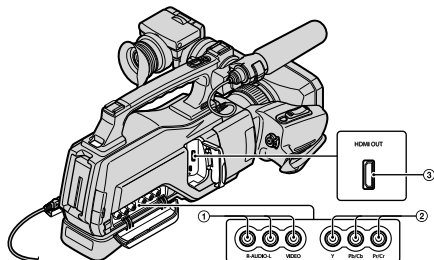

Connecting to a high definition TV

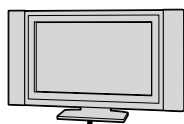

High definition image quality (HD) movies are played back in high definition image quality (HD).

Standard definition image quality (STD) movies are played back in standard definition image quality (STD).



: Signal flow

| Type | Camcorder | Cable | TV | Menu Setting |
|------|-----------|-------|----|--------------|
|------|-----------|-------|----|--------------|

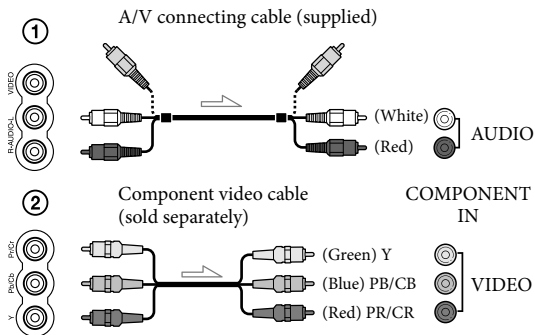
A

[Show others] menu →
 [OUTPUT SETTINGS]
 (under  [GENERAL
 SET] category) →
 [COMPONENT] →
 [1080i/480i] (p. 91)

 Notes

- If you connect only component video cable (sold separately), audio signals are not output. Connect the white and red plugs to output audio signals.

: Signal flow

| Type | Camcorder | Cable | TV | Menu Setting |
|------|-----------|-------|----|--------------|
|------|-----------|-------|----|--------------|

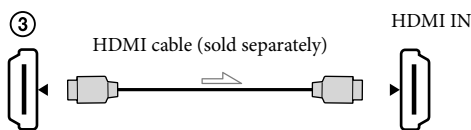
B

[Show others] menu →
 [OUTPUT SETTINGS]
 (under  [GENERAL
 SET] category) →
 [HDMI RESOLUTION]
 → [HD CONTENTS]/
 [STD CONTENTS] →
 [AUTO] (p. 91)

 Notes

- **Use an HDMI cable with the HDMI logo.**
- Images are not output from the HDMI OUT jack of your camcorder, if copyright protection signals are recorded in the movies.
- Your TVs may not function correctly (for example, no sound or image).
- Select [HD CONTENTS] or [STD CONTENTS] according to on the recorded image quality (p. 91).
- Do not connect the HDMI OUT jack of your camcorder and HDMI OUT jack of the external device with the HDMI cable. This may cause a malfunction.
- This camcorder is not compatible with “BRAVIA” sync.

Connecting to a non-high-definition 16:9 (wide) or 4:3 TV

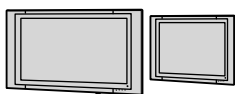

High definition image quality (HD) movies are played back in standard definition image quality (STD).
Standard definition image quality (STD) movies are played back in standard definition image quality (STD).

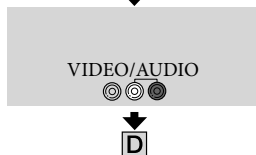
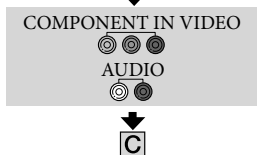

: Signal flow

| Type | Camcorder | Cable | TV | Menu Setting |
|------|-----------|-------|----|--------------|
|------|-----------|-------|----|--------------|

C

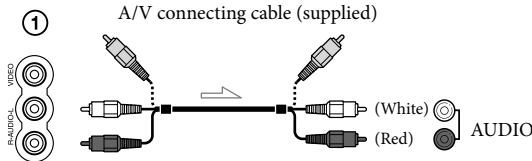

[Show others] menu →
[OUTPUT SETTINGS]
(under [GENERAL SET] category) →
[COMPONENT] →
[1080i/480i] (p. 91)

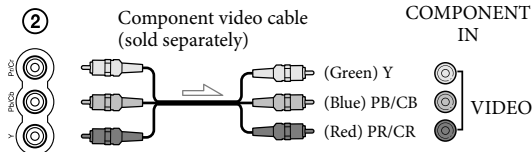





[OUTPUT SETTINGS]
→ [TV TYPE] →
[16:9]/[4:3]* (p. 90)

* Change the settings according to the TV connected.

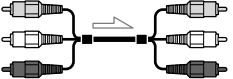
Notes

- If you connect only component video cable (sold separately), audio signals are not output. Connect the white and red plugs to output audio signals.

| Type | Camcorder | Cable | TV | Menu Setting |
|----------|---|---|--|---|
| D | ① | A/V connecting cable (supplied) | | [Show others] menu → [OUTPUT SETTINGS] (under [GENERAL SET] category) → [TV TYPE] → [16:9]/[4:3]* (p. 90) |
| |  |  | (Yellow)  VIDEO (White)  AUDIO (Red)  | |

* Change the settings according to the TV connected.

When connecting to your TV via a VCR

- Connect your camcorder to the LINE IN input on the VCR using the A/V connecting cable. Set the input selector on the VCR to LINE (VIDEO 1, VIDEO 2, etc.).





To set the aspect ratio according to the connected TV (16:9/4:3)

- Set [TV TYPE] to [16:9] or [4:3] according to your TV (p. 90).

When your TV is monaural (When your TV has only one audio input jack)

- Connect the yellow plug of the A/V connecting cable to the video input jack and connect the white (left channel) or red (right channel) plug to the audio input jack of your TV or VCR.

Notes

- When you play back standard definition image quality (STD) movies on a 4:3 TV that is not compatible with the 16:9 signal, record movies with 4:3 aspect ratio. Touch **MENU** (MENU) → [Show others] → [OTHER REC SET] (under  [SHOOTING SET] category) → [ WIDE SELECT] → [4:3] → **OK** →  →  (p. 84).

Tips

- If you connect your camcorder to the TV using more than one type of cable to output images, the order of priority of the TV input jacks is as follows:
HDMI → component → video
- HDMI (High Definition Multimedia Interface) is an interface to send both video/audio signals. The HDMI OUT jack outputs high quality images and digital audio.

On "Photo TV HD"

This camcorder is compatible with the "Photo TV HD" standard. "Photo TV HD" allows for highly-detailed, photo-like depiction of subtle textures and colors.

By connecting Sony's Photo TV HD-compatible devices using an HDMI cable* or the component video cable**, a whole new world of photos can be enjoyed in breathtaking full HD quality.

* The TV will automatically switch to the appropriate mode when displaying photos.

** Setup of the TV will be necessary. Please refer to the instructions of your Photo TV HD-compatible TV for details.

Deleting movies and photos

You can free media space by deleting movies and photos from recording media.

Notes

- You cannot restore images once they are deleted. Save important movies and photos in advance.
- Do not remove the battery pack or the AC Adaptor from your camcorder while deleting the images. It may damage the recording media.
- Do not eject memory card while deleting images from the memory card.
- You cannot delete protected movies and photos. Undo the protection of the movies and photos to delete them, before you try to delete them (p. 45).
- If the deleted movie is included in the Playlist (p. 50), the movie added to the Playlist is deleted also from the Playlist.
- If the deleted movie is included in the saved Highlight Playback scenario (p. 38), the movie is also deleted from the scenario.

Tips

- You can delete an image on the playback screen from **OPTION MENU**.
- To delete all images recorded in the recording media, and recover all the recordable space of the media, format the media (p. 88).
- Reduced-size images which enable you to view many images at the same time on an index screen are called “thumbnails.”

1 Touch **MENU** (MENU) → [Show others] → [DELETE] (under **[EDIT]** category).

2 To delete movies, touch **[DELETE]** → **[HDD:DELETE]** or **[HSD:DELETE]**.

- To delete photos, touch **[DELETE]** → **[DELETE]**.

3 Touch and display the ✓ mark on the movies or photos to be deleted.

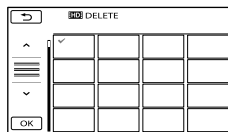

- Press and hold the image down on the LCD screen to confirm the image. Touch **[RETURN]** to return to the previous screen.

4 Touch **OK** → [YES] → **OK** → **X**.

To delete all movies/photos at one time

In step 2, touch **[HDD:DELETE]** → **[HDD:DELETE ALL]**/**[HSD:DELETE ALL]** → [YES] → [YES] → **OK** → **X**.

- To delete all photos at one time, touch **[DELETE]** → **[DELETE ALL]** → [YES] → [YES] → **OK** → **X**.

To delete all the movies/photos recorded on the same day at one time

Notes

- You cannot delete photos on memory card by recording date.

① In step 2, touch **[HDD:DELETE]** → **[HDD:DELETE by date]**/**[HSD:DELETE by date]**.

- To delete all photos on the same day at one time, touch **[DELETE]** → **[DELETE by date]**.

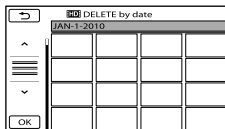

② Touch **▲**/**▼** to select the recording date of the desired movies/photos, then touch **OK**.

- Touch the image on the LCD screen to confirm the image. Touch **↶** to return to the previous screen.

③ Touch [YES] → **OK** → **×**.

Protecting recorded movies and photos (Protect)

Protect movies and photos to avoid deleting them by mistake.

Tips

- You can protect movies and photos on the playback screen from **OPTION MENU**.

1 Touch **MENU** (MENU) → [Show others] → [PROTECT] (under **[EDIT]** category).

2 To protect movies, touch **[PROTECT]** → **[HDD PROTECT]**/**[STD PROTECT]**.

- To protect photos, touch **[PROTECT]** → **[PROTECT]**.

3 Touch the movies and photos to be protected.

⏏ is displayed on the selected images.

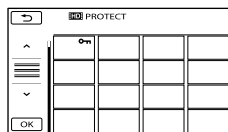

- Press and hold the image down on the LCD screen to confirm the image. Touch **↶** to return to the previous screen.

4 Touch **OK** → [YES] → **OK** → **×**.

Dividing a movie

To undo the protection of movies and photos





Touch the movie or photo marked with  in step 3.

 disappears.





To protect all the movies and photos recorded on the same day at one time

⚡ Notes

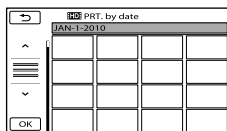
- You cannot select [ PRT. by date] for still images recorded on the memory card.



- ① In step 2, touch [ PROTECT] → [ PRT. by date]/[ PRT. by date].
 - To protect all photos on the same day at one time, touch [ PROTECT] → [ PRT. by date].





- ② Touch  /  to select the recording date of the desired movies/photos, then touch .
 - Touch the image on the LCD screen to confirm the image. Touch  to return to the previous screen.



- ③ Touch [PROTECT] →  → .

To undo the protection of movies and photos recorded on the same day at one time

In step ② above, select the recording date of the desired movies/photos, then touch  → [UNPROTECT] →  → .

- 1 Touch  (MENU) → [Show others] → [ DIVIDE] (under  [EDIT] category).

- 2 Touch the movie to be divided.
The selected movie starts playback.

- 3 Touch  at the point where you want to divide the movie into scenes.
The movie pauses. Play and pause toggles as you press .

The movie pauses. Play and pause toggles as you press .

Adjusts the dividing point with more precision after you selected the dividing point with .



Returns to the beginning of the selected movie

- 4 Touch  → [YES] → .

⚡ Notes

- You cannot restore movies once they are divided.
- You cannot divide protected movie. Undo the protection of the movie to divide it, before you try to divide it (p. 45).
- Do not remove the battery pack or the AC Adaptor from your camcorder while dividing the movie. It may damage the recording media. Also, do not eject the memory card while dividing movies on the memory card.

Capturing a photo from a movie

- A slight difference may occur from the point where you touch  and the actual dividing point, as your camcorder selects the dividing point based on about half-second increments.
- If you divide the original movie, the movie added to the Playlist will also be divided.
- If the divided movie is included in the saved Highlight Playback scenario (p. 38), the movie is deleted from the scenario.
- Only simple editing is available on the camcorder. Use the supplied software “PMB” for more advanced editing.

Tips

- You can divide a movie on the playback screen from  OPTION MENU.

You can capture photos from movies recorded on the internal memory of your camcorder. Set [MOVIE MEDIA SET] to [INT. MEMORY] beforehand (p. 20).

- 1 Touch  (MENU) → [Show others] → [PHOTO CAPTURE] (under  [EDIT] category).

The [PHOTO CAPTURE] screen appears.

- 2 Touch the movie to be captured.

The selected movie starts playback.

- 3 Touch  at the point where you want to capture.

The movie pauses. Play and pause toggles as you press .

Adjust the capturing point with more precision after you selected the point with

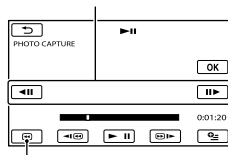



Returns to the beginning of the selected movie

- 4 Touch .

When capturing is finished, the screen returns to pause.

- The captured photo is saved on the recording media selected in [PHOTO MEDIA SET] (p. 20).

- To continue capturing, touch , then repeat steps from step 3.
- To capture a photo from another movie, touch , then repeat steps from step 2.

5 Touch  → .

Notes

- The image size is fixed depending on the image quality of the movie:
 - [2.1M] with high definition image quality (HD)
 - [0.2M] in 16:9 (wide) with standard definition image quality (STD)
 - [VGA(0.3M)] in 4:3 with standard definition image quality (STD)
- The recording medium where you want to save photos should have enough free space.
- The recording date and time of captured photos is the same as the recording date and time of the movies.
- If the movie you are capturing from has no data code, the recording date and time of the photo will be the date and time you captured from the movie.

Dubbing/copying movies and photos from the internal memory to memory card

Dubbing movies

You can dub movies recorded on the internal memory of your camcorder to memory card.

Insert memory card into your camcorder before the operation.

Notes

- When you record a movie on the memory card for the first time, create the image database file by touching **MENU** (MENU) → [Show others] → [REPAIR IMG.DB F.] (under [MANAGE MEDIA] category) → [MEMORY CARD].
- Connect your camcorder to the wall outlet (wall socket) using the supplied AC Adaptor to prevent your camcorder from running out of power during dubbing.

Tips

- The original movie will not be deleted after dubbing.
- All included images in a Playlist will be dubbed.
- The images recorded by this camcorder and stored onto the recording media are called “original.”

1 Touch **MENU** (MENU) → [Show others] → [MOVIE DUB] (under [EDIT] category).

The [MOVIE DUB] screen appears.

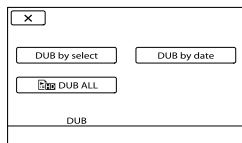

2 Touch the type of dubbing.

[DUB by select]: To select movies and dub

[DUB by date]: To dub all movies of a specified date

[DUB ALL]: To dub the high definition image quality (HD) Playlist

[DUB ALL]: To dub the standard definition image quality (STD) Playlist

When you select the Playlist as the source of dubbing, follow the on-screen instructions to dub the Playlist.

3 Select the movie to be dubbed.

[DUB by select]: Touch the movie to be dubbed, and mark it with . You can select multiple movies.

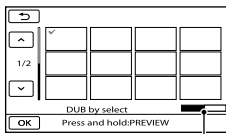

Remaining capacity of the memory card

- Press and hold the image down on the LCD screen to confirm the image. Touch to return to the previous screen.

[DUB by date]: Select the recording date of the movie to be dubbed, then touch . You cannot select multiple dates.

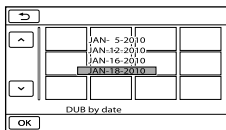

4 Touch → [YES] → → .

Tips

- To check the dubbed movies after dubbing is finished, select [MEMORY CARD] on [MOVIE MEDIA SET] and play them back (p. 20).

Copying photos

You can copy photos from the internal memory of the camcorder to memory card. Insert a memory card into your camcorder before the operation.

Notes

- Connect your camcorder to the wall outlet (wall socket) using the supplied AC Adaptor to prevent your camcorder from running out of power during copying.

1 Touch (MENU) → [Show others] → [PHOTO COPY] (under [EDIT] category).

The [PHOTO COPY] screen appears.

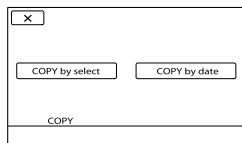

2 Touch the type of copying.

[COPY by select]: To copy selected photos

[COPY by date]: To copy all photos of a specified date

3 Select the photo to be copied.

[COPY by select]: Touch the photo to be copied, and mark with ✓. You can select multiple photos.

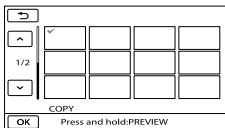

- Press and hold the image down on the screen to confirm the image. Touch to return to the previous screen.

[COPY by date]: Select the recording date of the photo to be copied, then touch . You cannot select multiple dates.

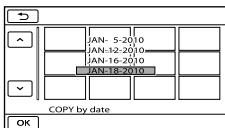

4 Touch → [YES] → → .

Tips

- To check the copied photos after copying is finished, select [MEMORY CARD] on [PHOTO MEDIA SET] and play them back (p. 20).

Using the Playlist of movies

The Playlist is a list showing thumbnails of the movies that you have selected.

The original movies are not changed even if you edit or erase the movies added to the Playlist.

Creating the Playlist

Notes

- High definition image quality (HD) movies and standard definition image quality (STD) movies are added to an individual Playlist.

1 Touch (MENU) → [Show others] → [PLAYLIST EDIT] (under [EDIT] category).

2 Touch [ADD] or [ADD].

3 Touch the movie to be added to the Playlist.

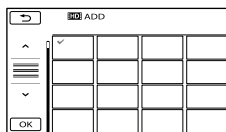

The selected movie is marked with ✓.

- Press and hold the image down on the LCD screen to confirm the image. Touch to return to the previous screen.

4 Touch → [YES] → → .

To add all the movies recorded on the same day at one time

- 1 In step 2, touch [HD: ADD by date]/ [STD: ADD by date].

The recording dates of movies are displayed on the screen.

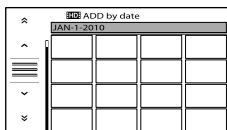

- 2 Touch [Up]/[Down] to select the recording date of the desired movie, then touch [OK].

- Touch the image on the LCD screen to confirm the image. Touch [Right] to return to the previous screen.

- 3 Touch [YES] → [OK] → [X].

Notes

- Do not remove the battery pack or the AC Adaptor from your camcorder while adding movies to the Playlist. It may damage the recording media. Also, do not eject the memory card while editing movies on the memory card.
- You cannot add photos to the Playlist.
- You cannot create a Playlist which contains both high definition image quality (HD) movies and standard definition image quality (STD) movies.

Tips

- You can add a maximum of 999 high definition image quality (HD) movies, or 99 standard definition image quality (STD) movies to the Playlist.
- You can add a movie on the playback screen or the Playlist screen by touching [OPTION].

Playing the Playlist

- 1 Touch [MENU] (MENU) → [Show others] → [PLAYLIST] (under [PLAYBACK] category).

Movies added to the Playlist appear.

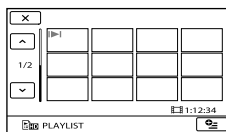

- 2 Touch the movie you want to play back.

The Playlist is played back from the selected movie to the end, then the screen returns to the Playlist screen.

To erase unnecessary movies from the Playlist

- 1 Touch [MENU] (MENU) → [Show others] → [PLAYLIST EDIT] (under [EDIT] category).
- 2 Touch [HD ERASE]/[STD ERASE]. To erase all the movies from the Playlist, touch [HD ERASE ALL]/[STD ERASE ALL] → [YES] → [YES] → [OK] → [X].
- 3 Select the movie to be erased from the list.

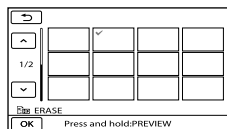

The selected movie is marked with ✓.

- Press and hold the image down on the LCD screen to confirm the image. Touch [Right] to return to the previous screen.

- ④ Touch **OK** → [YES] → **OK** → **X**.

Tips

- Even if you erase a movie from a Playlist, the original movie is not deleted.

To change the order within the Playlist

- ① Touch **MENU** (MENU) → [Show others] → [PLAYLIST EDIT] (under [EDIT] category).
- ② Touch [**EDIT** MOVE]/[**EDIT** MOVE].
- ③ Select the movie to be moved.

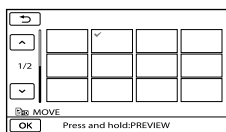

The selected movie is marked with ✓.

- Touch the image on the LCD screen to confirm the image. Touch **↩** to return to the previous screen.

- ④ Touch **OK**.
- ⑤ Select the destination with **←** / **→**.

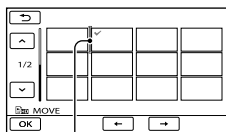

Destination bar

- ⑥ Touch **OK** → [YES] → **OK** → **X**.

Tips

- When you select multiple movies, the movies are moved following the order appearing in the Playlist.

Preparing a computer

(Windows)

You can perform following operations using “PMB (Picture Motion Browser).”

- Importing images to a computer
- Viewing and editing imported images
- Creating a disc
- Uploading movies and photos to websites

To save movies and photos using a computer, install “PMB” from the supplied CD-ROM beforehand.

Notes

- Do not format the media of your camcorder from a computer. Your camcorder may not operate correctly.
- This camcorder captures high definition footage in the AVCHD format. Using the enclosed PC software, high definition footage can be copied onto DVD media. However, DVD media containing AVCHD footage should not be used with DVD based players or recorders, as the DVD player/recorder may fail to eject the media and may erase its contents without warning.

Step 1 Checking the computer system

| |
|---|
| OS*1 |
| Microsoft Windows XP SP3*2/Windows Vista SP2*3/Windows 7 |
| CPU*4 |
| Intel Core Duo 1.66 GHz or faster, or Intel Core 2 Duo 1.66 GHz or faster (Intel Core 2 Duo 2.26 GHz or faster is required when processing HD FX/HD FH movies) However, Intel Pentium III 1 GHz or faster is sufficient for the following operations: – Importing the movies and photos to the computer – One Touch Disc Burn – Creating an Blu-ray Disc/AVCHD disc/DVD-video (Intel Core Duo 1.66 GHz or faster is required when creating a DVD video by converting high definition image quality (HD) to standard definition image quality (STD).) – Copying a disc – Processing only the movies with standard definition image quality (STD) |
| Application |
| DirectX 9.0c or later (This product is based on DirectX technology. It is necessary to have DirectX installed.) |
| Memory |
| For Windows XP: 512 MB or more (1 GB or more is recommended.) However, 256 MB or more is sufficient for processing only the movies with standard definition image quality (STD). For Windows Vista/Windows 7: 1 GB or more |
| Hard disk |
| Disk volume required for installation: Approximately 500 MB (10 GB or more may be necessary when creating AVCHD discs. 50 GB maximum may be necessary when creating Blu-ray Disc.) |
| Display |
| Minimum 1,024 × 768 dots |

Others

USB port (this must be provided as standard, Hi-Speed USB (USB 2.0 compatible)), Blu-ray Disc/DVD burner (CD-ROM drive is necessary for installation) Either NTFS or exFAT file system is recommended as the hard disk file system.

- *1 Standard installation is required. Operation is not assured if the OS has been upgraded or in a multi-boot environment.
- *2 64-bit editions and Starter (Edition) are not supported. Windows Image Mastering API (IMAPI) Ver.2.0 or newer is required to use disc creation function, etc.
- *3 Starter (Edition) is not supported.
- *4 Faster processor is recommended.

Notes

- Operation with all computer environments is not assured.

When using a Macintosh

The supplied software “PMB” is not supported by Macintosh computers. To import the movies and photos to the computer, please contact Apple Inc..

Step 2 Installing the supplied software “PMB”

Install “PMB” before connecting your camcorder to a computer.

Notes

- If a version of “PMB” under 5.0.00 has been installed on your computer, you may be unable to use some functions of those “PMB” when installing the “PMB” from the supplied CD-ROM. Also, “PMB Launcher” is installed from the supplied CD-ROM and you can start “PMB” or other software by using the “PMB Launcher.” Double-click the “PMB Launcher” short-cut icon on the computer screen to start “PMB Launcher.”

1 Confirm that your camcorder is not connected to the computer.

2 Turn on the computer.

- Log on as an Administrator for installation.
 - Close all applications running on the computer before installing the software.
-

3 Place the supplied CD-ROM in the disc drive of your computer.

The installation screen appears.

- If the screen does not appear, click [Start] → [Computer] (in Windows XP, [My Computer]), then double-click [SONYPMB (E:)] (CD-ROM)*.

* Drive names (such as (E:)) may vary depending on the computer.

4 Click [Install].



5 Select the country or region.

6 Select the language for the application to be installed, then proceed to the next screen.

7 Read the terms of the license agreement carefully. If you agree to the terms, change to , and then click [Next] → [Install].

-
- 8** Turn on your camcorder, then connect the camcorder to the computer using the supplied USB cable.

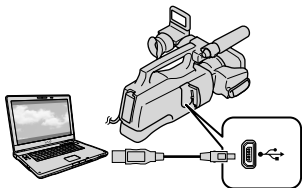

The [USB SELECT] screen appears on the camcorder screen automatically.

-
- 9** Touch the one of the media types displayed on the camcorder screen to make the computer recognize your camcorder.

[ USB CONNECT]: (internal memory)

[ USB CONNECT]: (memory card)

- If the [USB SELECT] screen does not appear, touch **MENU** (MENU) → [Show others] → [USB CONNECT] (under  [OTHERS] category).

-
- 10** Click [Continue] on the computer screen.

-
- 11** Follow the on-screen instructions to install the software.

- Connect the camcorder to the computer during the installation of “PMB.”
- Depending on the computer, you may need to install third party software. If the installation screen appears, follow the instructions to install the required software.

- Restart the computer if required to complete the installation.

When the installation is completed, following icons will appear.

Remove the CD-ROM from your computer.

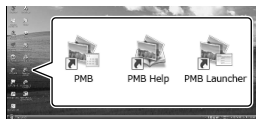

: Starts “PMB.”

: Displays “PMB Help.”

: Displays “PMB Launcher.”

“PMB Launcher” enables you to start “PMB” or other software, or to open web sites.

- Other icons may appear.
- No icon may appear depending on the installation procedure.

Notes

- To create discs or use other functions on Windows XP, Image Mastering API v2.0 for Windows XP should be installed. If Image Mastering API v2.0 for Windows XP has not been installed yet, select it from required programs on the installation screen and install it following the procedures displayed. (The computer must be connected to the internet for the installation.) You may install Image Mastering API v2.0 for Windows XP in response to the message displayed when you try to start those functions.

Starting PMB (Picture Motion Browser)

To disconnect your camcorder from the computer

- 1 Click the  icon at the bottom right of the desktop of the computer → [Safely remove USB Mass Storage Device].



- 2 Touch [END] → [YES] on the camcorder screen.
- 3 Disconnect the USB cable.

⚡ Notes

- Access from the computer using the supplied software “PMB.” Do not modify the files or folders on the camcorder from the computer. The image files may be destroyed or may not be played back.
- When importing a long movie or edited image, use the supplied software “PMB.” If you use any other software, images may not be imported properly.
- If file size exceeds 2 GB during a long recording, a new file is created automatically, resulting in the movie being divided into multiple files when you view the recording media directly from your computer after recording.
- If you import images without using supplied “PMB,” files automatically created (due to the 2 GB limit) may not be concatenated. Even if you usually use other editing software, use the supplied software “PMB” to import images to the computer to ensure files are concatenated and imported to the computer.
- Operation is not guaranteed, if you perform the above operation.
- When you delete image files, follow the steps on page 44. Do not delete the image files on the camcorder directly from the computer.
- Do not copy the files on the recording media from the computer. Operation is not guaranteed.
- You can create a Blu-ray Disc by using a computer with a Blu-ray Disc burner. Install the BD Add-on Software for “PMB” (p. 62).

Double-click the “PMB” short-cut icon on the computer screen.



⚡ Notes

- If the icon is not displayed on the computer screen, click [Start] → [All Programs] → [PMB] to start “PMB.”

You can view, edit, or create discs of movies and photos using “PMB.”

Reading “PMB Help”

For details on how to use “PMB,” read the “PMB Help.” Double-click the “PMB Help” short-cut icon on the computer screen to open the “PMB Help.”











⚡ Notes

- If the icon is not displayed on the computer screen, click [Start] → [All Programs] → [PMB] → [PMB Help]. You can also open the “PMB Help” from [Help] of “PMB.”

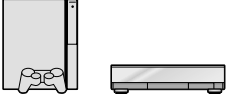
Selecting the method for creating a disc (computer)

Several methods for creating a high definition image quality (HD) disc or a standard definition image quality (STD) disc from high definition image quality (HD) movies or photos recorded on your camcorder are described here. Select the method that suits your disc player.

| Player | Choosing a method and disc type | |
|---|--|---|
| Blu-ray Disc playback devices (a Blu-ray Disc player, PlayStation®3, etc.)  | ① Importing movies and photos to a computer (p. 60) ↓ ② Creating a Blu-ray Disc* with high definition image quality (HD) (p. 62) |  |
| AVCHD format playback devices (a Sony Blu-ray Disc player, PlayStation®3, etc.)  | Creating a disc with one touch (One Touch Disc Burn) (p. 59) |  |
|  |  ① Importing movies and photos to a computer (p. 60) ↓ ② Creating a AVCHD format disc with high definition image quality (HD) (p. 61) |  |
| Ordinary DVD playback devices (a DVD player, a computer that can play DVDs, etc.)  | ① Importing movies and photos to a computer (p. 60) ↓ ② Creating a standard definition image quality (STD) disc (p. 63) |  |

* To create a Blu-ray Disc, the BD Add-on Software for “PMB” must be installed (p. 62).

⚡ Notes

- In this manual, the DVD disc recorded with high definition image quality (HD) is called AVCHD disc.

Characteristics of each type of disc

 Using a Blu-ray Disc enables you to record high definition image quality (HD) movies of a longer duration than DVD discs.

 High definition image quality (HD) movie can be recorded on DVD media, such as DVD-R discs, and a high definition image quality (HD) disc is created. You can play a high definition image quality (HD) disc on AVCHD format playback devices, such as a Sony Blu-ray Disc player and a PlayStation®3. You cannot play the disc on ordinary DVD players.

 Standard definition image quality (STD) movie converted from high definition image quality (HD) movie can be recorded on DVD media, such as DVD-R discs, and a standard image quality (STD) disc is created.

Discs you can use with “PMB”

You can use 12 cm discs of following type with “PMB.” For Blu-ray Disc, see page 62.

| Disc type | Features |
|----------------------|--------------|
| DVD-R/DVD+R/DVD+R DL | Unrewritable |
| DVD-RW/DVD+RW | Rewritable |

Notes

- Always maintain your PlayStation®3 to use the latest version of the PlayStation®3 system software.
- The PlayStation®3 may not be available in some countries/regions.

Creating a disc with one touch

(One Touch Disc Burn)

Movies and photos recorded on your camcorder that have not yet been saved with One Touch Disc Burn function can be saved on a disc automatically. Movies and photos are saved on a disc with their recorded image quality.

⚡ Notes

- High definition image quality (HD) movies (the default setting) will make an AVCHD disc.
- You cannot create AVCHD discs from movies recorded with [HD FX] mode of [REC MODE].
- Creating a Blu-ray disc is not available with One Touch Disc Burn.
- To create a standard definition image quality (STD) disc from high definition image quality (HD) movies, import movies to a computer first (p. 60), and then create a standard definition image quality (STD) disc (p. 63).
- Install “PMB” beforehand (p. 54), however, do not start “PMB.”
- Connect your camcorder to the wall outlet (wall socket) using the AC Adaptor supplied for this operation (p. 14).
- With One Touch Disc Burn function on your camcorder, you can save movies and photos recorded on the internal memory only.

1 Turn on your computer, and place an unused disc on the DVD drive.

- See page 58 for the type of discs you can use.
- If any other software than “PMB” starts automatically, shut it down.

2 Turn on your camcorder, then connect the camcorder to the computer using the supplied USB cable.

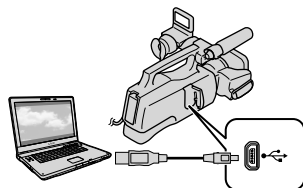

The [USB SELECT] screen appears on the camcorder screen.

3 Press [DISC BURN] on the LCD screen.

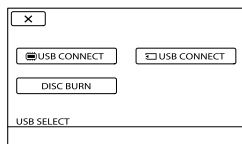

4 Follow the instructions on the computer screen.

⚡ Notes

- Movies and photos are not saved on the computer when you perform One Touch Disc Burn.

Importing movies and photos to a computer

Movies and photos recorded on your camcorder can be imported to a computer. Turn on the computer beforehand.

Notes

- Connect your camcorder to the wall outlet (wall socket) using the supplied AC Adaptor for this operation (p. 14).

- 1 Turn on your camcorder, then connect the camcorder to the computer using the supplied USB cable.

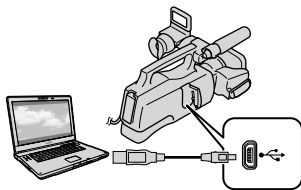

The [USB SELECT] screen appears on the camcorder screen.

- 2 Touch the recording media that contains the images you want to save on the camcorder screen.

[ USB CONNECT]: Internal memory

[ USB CONNECT]: Memory card

- If the [USB SELECT] screen does not appear, touch **MENU** (MENU) → [Show others] → [USB CONNECT] (under  [OTHERS] category).

The window for import appears on the computer screen.

- 3 Click [Import].

- Refer to “PMB Help” (p. 56) for details.

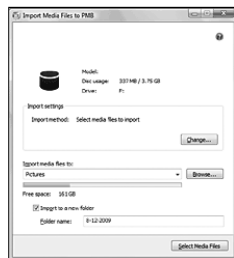

Movies and photos are imported to your computer.

When the operation is completed, the “PMB” screen appears.

Editing movies

You can cut out only necessary parts from a movie and save it as another file.

Double-click the movie to be edited on “PMB,” then click [Show Edit Palette] on the right side of the screen → [Trim Video], or select the [Manipulate] menu → [Edit] → [Trim Video]. See “PMB Help” (p. 56) for details.

Creating an AVCHD disc

Capturing photos from a movie

You can save a frame of a movie as a photo file.

Double-click the movie to be edited on “PMB,” then click [Show Edit Palette] on the right side of the screen → [Save Frame]. See “PMB Help” (p. 56) for details.



You can create an AVCHD disc by putting together high definition image quality (HD) movies previously imported to your computer (p. 60).

In this section, the procedure for recording a high definition image quality (HD) movie on a DVD disc is explained.

1 Turn on your computer, and place an unused disc on the DVD drive.

- See page 57 for the type of discs you can use.
- If any other software than “PMB” starts automatically, shut it down.

2 Start “PMB” (p. 56).

3 Click [Calendar] or [Index] on the left side in the window, and select the date or folder, then select the high definition image quality (HD) movies.

- High definition image quality (HD) movies are marked with **HD**.
- You cannot save photos on a disc.
- To select plural movies, hold the Ctrl key down and click thumbnails.

4 At the top of the window, click  → [Create AVCHD Format Discs (HD)].



The window used to select movies

appears.

- To add movies to the previously selected ones, select the movies in the main window and drag and drop onto the window for selecting movies.

5 Follow the instructions on the screen to create a disc.

- It may take a long time to create a disc.

Playing an AVCHD disc on a computer

You can play back AVCHD discs using “Player for AVCHD” that is installed together with “PMB.”

To start “Player for AVCHD” Click [Start] → [All Programs] → [PMB] → [PMB Launcher] → [View] → [Player for AVCHD].

See the “Player for AVCHD” help on the operation.

- Movies may not be played smoothly depending on the computer environment.

Creating a Blu-ray Disc

You can create a Blu-ray Disc with a high definition image quality (HD) movie previously imported to a computer (p. 60).

To create a Blu-ray Disc, the BD Add-on Software for “PMB” must be installed. Click [BD Add-on Software] on the installation screen of “PMB,” and install this plug-in according to the on-screen instructions.

- Connect your computer to the internet when you install [BD Add-on Software].



Place an unused Blu-ray Disc in the disc drive, and click  → [Create Blu-ray Disc (HD)] in step 4 of “Creating an AVCHD disc” (p. 61). Other procedures are the same as that for creating an AVCHD disc.

- Your computer must support the creation of Blu-ray Disc.
- BD-R (unrewritable) and BD-RE (rewritable) media are available for creating Blu-ray Disc. You cannot add contents to either type of disc after creating the disc.

Creating a standard definition image quality (STD) disc that can be played on ordinary DVD players

You can create a standard definition image quality (STD) disc by selecting movies previously imported to your computer (p. 60).

🔗 Notes

- You may select high definition image quality (HD) movies as sources. However, image quality is converted from high definition (HD) to standard definition (STD). It will take a longer time for converting the image quality of the movies than it took to actually record the movies.

1 Turn on your computer, and place an unused disc on the DVD drive.

- See page 58 for the type of discs you can use.
- If any other software than “PMB” starts automatically, shut it down.

2 Start “PMB” (p. 56).

3 Click [Calendar] or [Index] on the left side in the window, and select the date or folder, then select the movies.

- High definition image quality (HD) movies are marked with **HD**.
- To select plural movies, hold the Ctrl key down and click thumbnails.

4 At the top of the window, click  → [Create DVD-Video Format Discs (STD)].

The window used to select movies appears.

- To add movies to the previously selected ones, select the movies in the main window and drag and drop onto the window for selecting movies.



5 Follow the instructions on the screen to create a disc.

- It may take a long time to create a disc.

Copying a disc

You can copy a recorded disc to another disc using “Video Disc Copier.”

Click [Start] → [All Programs] → [PMB] → [PMB Launcher] → [Disc creation] → [Video Disc Copier] to start the software. See “Video Disc Copier” help on the operation.

- You cannot copy high definition image quality (HD) movies by converting them to standard definition image quality (STD).
- You cannot copy to a Blu-ray Disc.

Saving images in external media

(DIRECT COPY)

You can save movies and photos on external media (USB storage device), such as an external hard disk drive. You can also play back images on the camcorder or another playback device.

ⓘ Notes

- You cannot use the following devices as an external media.
 - media with a capacity exceeding 2 TB
 - ordinary disc drive such as CD or DVD drive
 - media connected via USB hub
 - media with built-in USB hub
 - card reader
- You may not be able to use external media with a code function.
- FAT file system is available for your camcorder. If the external media was formatted to NTFS file system, etc., format the external media on your camcorder before use. The format screen appears when the external media is connected to your camcorder. However, the format screen may appear even if you use the external media of FAT file system.
- Operation is not assured with every device satisfying requirements for operating.
- Connect your camcorder to the wall outlet (wall socket) using the supplied AC adaptor (p. 14).
- Refer to the instruction manual supplied with the external media.

💡 Tips

- You can import images saved in the external media by using the supplied software “PMB.”

- 1 Connect the AC Adaptor and the power cord (mains lead) to the DC IN jack of your camcorder and the wall outlet (wall socket).

- 2 If the external media has the AC power cable, connect it to the wall outlet (wall socket).

- 3 Connect the USB Adaptor Cable to the external media.

- 4 Connect the USB Adaptor Cable to the Ψ (USB) jack of your camcorder.

When the [Create a new Image Database File.] screen appears, touch [YES].

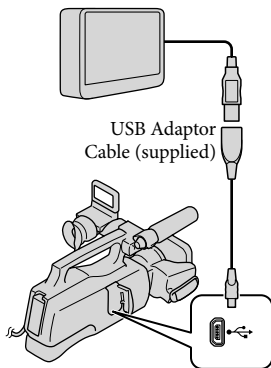

[EASY COPY] screen is displayed on the LCD screen.

- 5 Touch [Copy.] on the camcorder screen.

Movies and photos in the internal memory of the camcorder that have not yet been saved on to external media can be saved.

- This screen will appear only when there are newly recorded images.

6 After the operation is completed, touch **OK** on the camcorder screen.

⚡ Notes

- The number of scenes you can save on the external media are as follows. However, even if the external media has free space, you cannot save scenes exceeding the following number.
High definition image quality (HD) movies:
Max. 3,999
Standard definition image quality (STD) movies: 9,999
Photos: 9,999 frames × 899 folders
The number of scenes may be smaller depending on the type of images recorded.
- If [Cannot save all images to the connected external media. Copy as much as possible?] is displayed, some of the images that have been selected to copy are not saved in external media. Images not yet copied are copied when you connect other external media.

When connecting an external media

The images saved in the external media are displayed on the LCD screen. The movie display and photo display buttons on the VISUAL INDEX screen change as illustrated below.

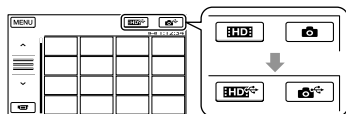

You can make menu settings of the external media such as deleting images. Touch **MENU** (MENU) → [Show others] on the VISUAL INDEX screen.

To save desired movies and photos
You can save images from the memory cards to the external media.

⚡ Notes

- You cannot copy or search photos by date which are recorded on the memory card.
- ① Touch [Play without copying.] in step 5 above.
The VISUAL INDEX screen of the external media is displayed.
 - ② Touch **MENU** (MENU) → [Show others] → [MOVIE DUB] (when selecting movies)/[PHOTO COPY] (when selecting photos).
 - ③ Follow the on-screen instructions to select the recording media and image selection methods.
 - ④ When you selected [DUB by select], touch the image to be saved.
✓ appears.

- When you selected [DUB by date], select the date of the images to be dubbed with **▲** / **▼**, then touch **OK** and go to step ⑤.

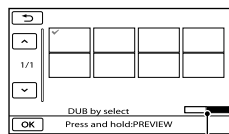

Remaining external media capacity

- Press and hold the image down on the LCD screen to confirm the image. Touch **↶** to return to the previous screen.
 - By touching date, you can search for images by date.
- ⑤ Touch **OK** → [YES] → **OK** on the camcorder screen.

Creating a disc with a DVD writer, recorder

To play back images in the external media on the camcorder

- ① Touch [Play without copying.] in step 5 above.

The VISUAL INDEX screen of the external media is displayed.

- ② Play back the image (p. 33).
 - You can also view images on a TV connected to your camcorder (p. 40).
 - You can play back the high definition image quality (HD) movies on your computer using [Player for AVCHD]. Start [Player for AVCHD], and select the drive where the external media is connected with [Settings].

⚡ Notes

- The Date Index of photos cannot be displayed.
- If your camcorder does not recognize the external media, try the following operations.
 - Reconnect the USB Adaptor Cable to your camcorder
 - If the external media has the AC power cable, connect it to the wall outlet (wall socket)

To finish the external media connection

- ① Touch  on the VISUAL INDEX screen of the external media.
- ② Disconnect the USB Adaptor Cable.

Selecting the method for creating a disc

Several methods for creating an AVCHD disc or a standard definition image quality (STD) disc from high definition image quality (HD) movies or photos recorded on your camcorder are described here. Select the method that suits your disc player.

⚡ Notes

- See page 57 for the type of discs you can use.
- See page 62 to create a Blu-ray Disc.
- Prepare a DVD disc such as a DVD-R, for creating a disc.
- See page 64 to save images in the external media.

AVCHD format compatible device

Player

- Sony Blu-ray Disc player
- PlayStation®3, etc.

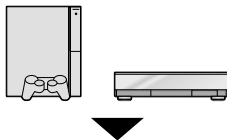

Creating device

- DVD writer, DVDExpress (p. 67)
- DVD writer, etc., other than DVDExpress (p. 69)

Disc type

- AVCHD disc (high definition image quality (HD))



Ordinary DVD device

Player

- DVD player
- Computer that can play DVDs, etc.



Creating device

- DVD writer, DVDirect Express (p. 67)
- DVD writer, other than DVDirect Express (p. 69)
- Disc recorder, etc. (p. 70)

Disc type

- Standard definition image quality (STD) disc



⚡ Notes

- Always maintain your PlayStation®3 to use the latest version of the PlayStation®3 system software.
- The PlayStation®3 may not be available in some countries/regions.
- The AVCHD disc can be played back only on AVCHD format compatible devices.
- The AVCHD disc should not be used in DVD players/recorders. Because DVD players/recorders are not compatible with the AVCHD format, DVD players/recorders may fail to eject the disc.
- You cannot create an AVCHD disc from a movie recorded with [HD FX] mode of [RECORD MODE]. Save a movie recorded with [HD FX] mode onto Blu-ray Disc or external storage devices (p. 62, 64).

Creating a disc with the dedicated DVD writer, DVDirect Express

You can create a disc or play back the images on a created disc by using the dedicated DVD writer, DVDirect Express (sold separately).

Refer also to the instruction manual supplied with the DVD writer.

⚡ Notes

- Connect your camcorder to the wall outlet (wall socket) using the supplied AC Adaptor for this operation (p. 14).
- Only unused discs of the following types can be used:
 - 12cm DVD-R
 - 12cm DVD+R
- The device does not support two-layered discs.
- DVDirect Express is referred to as “DVD writer” in this section.

- 1 Connect the AC Adaptor and the power cord (mains lead) to the DC IN jack of your camcorder and the wall outlet (wall socket) (p. 14).

- 2 Turn on your camcorder, and connect the DVD writer to the  (USB) jack of your camcorder with the USB cable of the DVD writer.

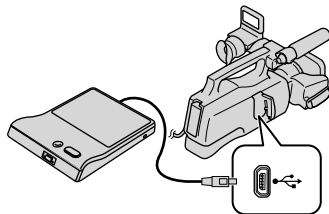

-
- 3** Insert an unused disc into the DVD writer, and close the disc tray.

The [DISC BURN] screen appears on the camcorder screen.

- 4** Press **DISC BURN** on the DVD writer.

Movies recorded on the internal memory that have not been saved on any discs will be recorded onto the disc.

- When there are unsaved high definition (HD) and standard definition (STD) image quality movies, they will be saved on individual discs according to the image quality.
-

- 5** Repeat steps 3 and 4 when the total memory size of movies to be burnt exceeds that of the disc.
-

- 6** Touch **OK** → [END] → [EJECT DISC] on the camcorder screen.

Remove the disc after the operation is completed.

- 7** Touch **OK**, then disconnect the USB cable.
-

To customize a disc with DISC BURN OPTION

Perform this operation in the following cases:

- When dubbing a desired image
- When creating multiple copies of the same

disc

- When converting high definition (HD) movies to standard definition (STD) movies, and creating a disc
- When dubbing images in the memory card

- 1** Touch [DISC BURN OPTION] in step 4.
2 Select the recording media containing the movie(s) you want to save.

When you select movies with high definition image quality (HD), the screen to select the image quality of the disc to be created appears on the LCD screen. Select the desired image quality, and touch **OK**.

- The image quality of the disc depends on the recording time of the selected movies when you create a disc converting them from high definition image quality (HD) to standard definition image quality (STD).

- 3** Touch the movie you want to burn on the disc.

✓ appears.

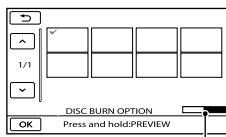

Remaining Disc capacity

- Press and hold the image down on the LCD screen to confirm the image. Touch **DISC BURN** to return to the previous screen.
- By touching date, you can search for images by date.

- 4** Touch **OK** → [YES] on the camcorder screen.

- To create another disc of the same contents, insert a new disc and touch [CREATE SAME DISC].

- 5** After the operation is completed, touch [EXIT] → [END] on the camcorder screen.

- ⑥ Disconnect the USB cable from your camcorder.

⚡ Notes

- Do not do any of the following when creating a disc.
 - Turn off the camcorder
 - Disconnect the USB cable or the AC adaptor
 - Subject the camcorder to mechanical shock or vibration
 - Eject the memory card from the camcorder
- Play the created disc to make sure dubbing was performed correctly before deleting the movies on your camcorder.
- If [Failed.] or [DISC BURN failed.] appears on the screen, insert another disc into the DVD writer and perform the DISC BURN operation again.

💡 Tips

- If the total memory size of movies to be burnt by the DISC BURN operation exceeds that of the disc, disc creation stops when the limit is reached. The last movie on the disc may be cut off.
- Disc creation time to dub movies to the limit of the disc is about 20 to 60 minutes. It may take more time depending on the recording mode or the number of scenes. Also, if high definition image quality (HD) is converted to standard definition image quality (STD), image quality conversion takes longer than the actual recording.

To play back a disc on the DVD writer

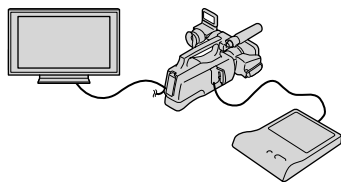

- ① Connect the AC Adaptor and the power cord (mains lead) to the DC IN jack of your camcorder and the wall outlet (wall

socket) (p. 14).

- ② Turn on your camcorder, and connect the DVD writer to the Ψ (USB) jack of your camcorder with the USB cable of the DVD writer.
 - You can play back movies on the TV screen by connecting the camcorder to a TV (p. 40).
- ③ Insert a created disc into the DVD writer.

The movies on the disc appear as VISUAL INDEX on the camcorder screen.
- ④ Press the play button on the DVD writer.
 - You can also operate by the camcorder screen.
- ⑤ Touch [END] → [EJECT DISC] on the camcorder screen and remove the disc after the operation is completed.
- ⑥ Touch **OK** and disconnect the USB cable.

To play back a disc on the ordinary DVD player

Select the standard image quality (STD) on the screen to select the image quality of the disc to be created in step 2 of “To customize a disc with DISC BURN OPTION.”

💡 Tips

- If you cannot play back created standard definition (STD) image quality discs on any DVD player, connect the camcorder to the DVD writer, and then play back.

Creating a high definition image quality (HD) disc with a DVD writer, etc., other than DVDDirect Express

Use USB cable to connect your camcorder to a disc creation device, which is compatible with high definition image quality (HD) movies, such as a Sony DVD

writer. Refer also to the instruction manuals supplied with the device to be connected.

⚡ Notes

- Connect your camcorder to the wall outlet (wall socket) using the supplied AC Adaptor for this operation (p. 14).
- Sony DVD writer may not be available in some countries/regions.
- Always maintain the firmware of the Sony DVDDirect (DVD writer) to its latest version. For details, see the following website.
<http://sony.storagesupport.com/>

1 Connect the AC Adaptor and the power cord (mains lead) to the DC IN jack of your camcorder and the wall outlet (wall socket) (p. 14).

2 Turn on your camcorder, and connect a DVD writer, etc. to the Ψ (USB) jack of your camcorder with the USB cable (supplied).

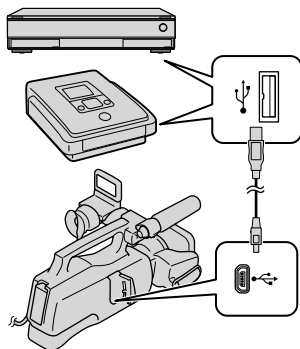

The [USB SELECT] screen appears on the camcorder screen.

- If the [USB SELECT] screen does not appear, touch **MENU** (MENU) → [Show

others] → [USB CONNECT] (under **☰** [OTHERS] category).

3 Touch the recording media that contains the images on the camcorder screen.

[**☰** USB CONNECT]: Internal memory

[**☑** USB CONNECT]: Memory card

4 Record movies on the connected device.

- For details, refer to the instruction manuals supplied with the device to be connected.

5 After the operation is completed, touch [END] → [YES] on the camcorder screen.

6 Disconnect the USB cable.

Creating a standard definition image quality (STD) disc with a recorder, etc.

You can dub images played back on your camcorder on a disc or video cassette, by connecting your camcorder to a disc recorder, a Sony DVD writer, etc., other than DVDDirect Express, with the A/V connecting cable. Connect the device as follows. Refer also to the instruction manuals supplied with the devices to be connected.

⚡ Notes

- Connect your camcorder to the wall outlet (wall socket) using the supplied AC Adaptor for this operation (p. 14).

- Sony DVD writer may not be available in some countries/regions.
- High definition image quality (HD) movies will be dubbed with standard definition image quality (STD).

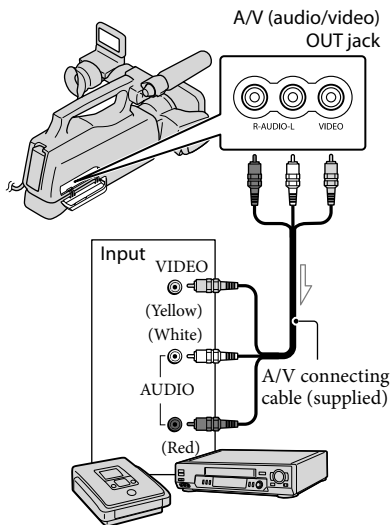

➞ Signal flow

1 Insert the recording media in the recording device.

- If your recording device has an input selector, set it to the input mode.

2 Connect your camcorder to the recording device (a disc recorder, etc.) with the A/V connecting cable (supplied).

- Connect your camcorder to the input jacks of the recording device.

3 Start playback on your camcorder, and record it on the recording device.

- Refer to the instruction manuals supplied with your recording device for details.

4 When dubbing is finished, stop the recording device, and then your camcorder.

⚡ Notes

- Since dubbing is performed via analog data transfer, the image quality may deteriorate.
- You cannot dub images to recorders connected with an HDMI cable.
- To hide the screen indicators (such as a counter, etc.) on the screen of the monitor device connected, touch **MENU** (MENU) → [Show others] → [OUTPUT SETTINGS] (under [GENERAL SET] category) → [DISP OUTPUT] → [LCD PANEL] (the default setting) → **OK** → → **X**.
- To record the date/time, or camera settings data, touch **MENU** (MENU) → [Show others] → [PLAYBACK SET] (under [PLAYBACK] category) → [DATA CODE] → a desired setting → **OK** → → **X**.

In addition, touch **MENU** (MENU) → [Show others] → [OUTPUT SETTINGS] (under [GENERAL SET] category) → [DISP OUTPUT] → [V-OUT/PANEL] → **OK** → → **X**.

- When the screen size of display devices (TV, etc.) is 4:3, touch **MENU** (MENU) → [Show others] → [OUTPUT SETTINGS] (under [GENERAL SET] category) → [TV TYPE] → [4:3] → **OK** → → **X**.
- When you connect a monaural device, connect the yellow plug of the A/V connecting cable to the video input jack, and the white (left channel) or the red (right channel) plug to the audio input jack on the device.

Using menus

Using the menus, you can perform useful functions and change various settings. If you make good use of menu operations, you can enjoy using your camcorder.

The camcorder has various menu items under each of eight menu categories.

M **MANUAL SETTINGS (Items to adjust for scene condition)** → p. 77

SHOOTING SET (Items for customized shooting) → p. 81

PHOTO SETTINGS (Items for recording photos) → p. 85

PLAYBACK (Items for playback) → p. 86

EDIT (Items for editing) → p. 87

OTHERS (Items for other settings) → p. 88

MANAGE MEDIA (Items for recording media) → p. 88

GENERAL SET (Other setup items) → p. 90

Operating menus

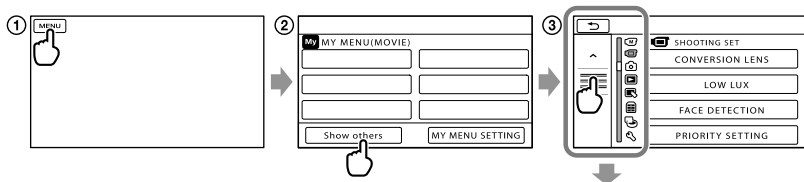

▲ / **▼** : The menu list moves from category to category.

▲ / **▼** : The menu list moves through 4 items at once.

• You can touch buttons and drag the screen to scroll the list of the menu.

• The selected category icon is displayed in orange.

• When you touch **MY**, the screen returns to the MY MENU screen.

① Touch **MENU** (MENU).

② Touch [Show others] on the MY MENU screen.

- See the next page for details on MY MENU.

③ Touch the central part of the left side of screen to change the display.

④ Touch the menu item to be changed.

⑤ After changing the setting, touch **OK**.

To finish setting the menu, touch **X**.

To return to the previous menu screen, touch **↶**.

- **OK** may not be displayed depending on the menu item.

⚡ Notes

- You may not be able to set some menu items, depending on the recording or playback conditions.
- Grayed out menu items or settings are not available.

💡 Tips

- Depending on the menu items being changed, your camcorder switches between playback mode and recording mode (movie/photo).

Using MY MENU

You can use the menu items more easily by registering the menu items you use most often on MY MENU. You can register 6 menu items on each MY MENU of the MOVIE, PHOTO, and PLAYBACK.

Example: deleting [SPOT MTR/FCS] and registering [LOW LUX]

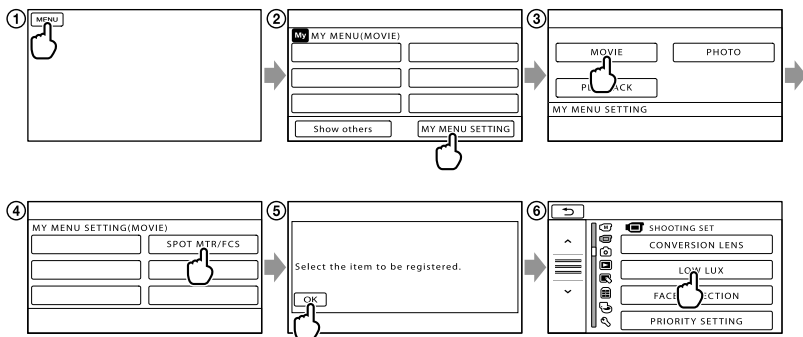



- 1 Touch **MENU** (MENU).
- 2 Touch **MY MENU SETTING**.
- 3 Touch **MOVIE**.
- 4 Touch **SPOT MTR/FCS**.
- 5 Touch **OK**.
- 6 Touch **LOW LUX** (under **SHOOTING SET** category).
- 7 When MY MENU is displayed, touch **×**.



💡 Tips

- When an external storage device is connected, the exclusive MY MENU appears.

Using the OPTION MENU

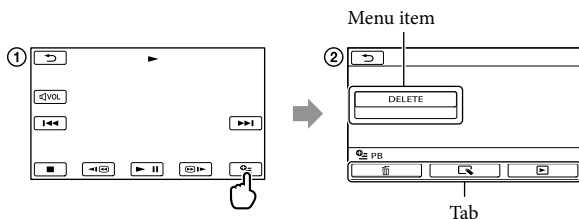
The OPTION MENU appears just like the pop-up window that appears when you right-click the mouse on a computer. When  is displayed at bottom-right of the screen, you can use the OPTION MENU. You touch , and the menu items you can change in the context appear.



- ① Touch  (OPTION).
- ② Touch the desired tab → the item to change the setting.
- ③ After completing the setting, touch .

Notes







- Grayed out menu items or settings are not available.
- When the item you want is not on the screen, touch another tab. (There may be no tab.)
- The tabs and items that appear on the screen depend on the recording/playback status of your camcorder at the time.

Menu lists



(MANUAL SETTINGS) category

| | |
|-----------------|----|
| SCENE SELECTION | 77 |
| WHITE BAL. | 77 |
| SPOT MTR/FCS | 78 |
| SPOT METER | 78 |
| SPOT FOCUS | 79 |
| EXPOSURE | 79 |
| FOCUS | 79 |
| TELE MACRO | 80 |
| AE SHIFT | 80 |
| WB SHIFT | 80 |
| SMTH SLW REC | 80 |

(SHOOTING SET) category





| | |
|---|----|
|  HDMI/SD SET | 28 |
|  REC MODE | 29 |
| GUIDEFAME | 81 |
|  STEADYSHOT | 82 |
| CONVERSION LENS | 82 |
| LOW LUX | 82 |
| FACE DETECTION | 82 |
| PRIORITY SETTING | 83 |
| SMILE DETECTION | 83 |
| SMILE SENSITIVITY | 83 |
| AUDIO REC SET | |
| MICREF LEVEL | 83 |
| OTHER REC SET | |
|  DIGITAL ZOOM | 83 |
| AUTO BACK LIGHT | 84 |
| RING SETTING | 84 |
|  X.V.COLOR | 84 |
|  WIDE SELECT | 84 |

(PHOTO SETTINGS) category



















| | |
|--|----|
|  SELF-TIMER | 85 |
|  IMAGE SIZE | 85 |
|  STEADYSHOT | 85 |
| FILE NO. | 85 |

(PLAYBACK) category



| | |
|---|----|
| VISUAL INDEX | 33 |
| VIEW IMAGES | |
| DATE INDEX | 36 |
|  FILM ROLL | 36 |

| | |
|---|----|
|  FACE | 36 |
| PLAYLIST | 51 |
|  HIGHLIGHT | 37 |
|  SCENARIO | 38 |
| PLAYBACK SET | |
|  HDMI/SD SET | 28 |
| DATA CODE | 86 |

(EDIT) category

| | |
|--|----|
| DELETE | |
|  DELETE | 44 |
|  DELETE | 44 |
|  SCENARIO ERASE | |
| ERASE | 38 |
| ERASE ALL | 38 |
| PROTECT | |
|  PROTECT | 45 |
|  PROTECT | 45 |
|  DIVIDE | 46 |
| PHOTO CAPTURE | 47 |
| MOVIE DUB | |
| DUB by select | 49 |
| DUB by date | 49 |
|  DUB ALL/  DUB ALL | 49 |
| PHOTO COPY | |
| COPY by select | 49 |
| COPY by date | 49 |
| PLAYLIST EDIT | |
|  ADD/  ADD | 50 |
|  ADD by date/  ADD by date | 51 |
|  ERASE/  ERASE | 51 |
|  ERASE ALL/  ERASE ALL | 51 |
|  MOVE/  MOVE | 52 |

(OTHERS) category

| | |
|---|----|
| USB CONNECT | |
|  USB CONNECT | 69 |
|  USB CONNECT | 69 |
| DISC BURN | 59 |
| BATTERY INFO | 88 |



(MANAGE MEDIA) category

| | |
|------------------|---------|
| MEDIA SETTINGS | |
| MOVIE MEDIA SET | 20 |
| PHOTO MEDIA SET | 20 |
| MEDIA INFO | 88 |
| MEDIA FORMAT | |
| INT. MEMORY | 88 |
| MEMORY CARD | 88 |
| REPAIR IMG.DB F. | |
| INT. MEMORY | 97, 101 |
| MEMORY CARD | 97, 101 |



(GENERAL SET) category

| | |
|--------------------|--------|
| SOUND/DISP SET | |
| VOLUME | 35, 90 |
| BEEP | 90 |
| LCD BRIGHT | 90 |
| LCD BL LEVEL | 90 |
| LCD COLOR | 90 |
| DISPLAY SET | 90 |
| OUTPUT SETTINGS | |
| TV TYPE | 90 |
| COMPONENT | 91 |
| HDMI RESOLUTION | 91 |
| DISP OUTPUT | 91 |
| CLOCK/🗓️LANG | |
| CLOCK SET | 16 |
| AREA SET | 92 |
| DST SET/SUMMERTIME | 92 |
| 🗓️LANGUAGE SET | 92 |
| POWER SETTINGS | |
| A.SHUT OFF | 92 |
| OTHER SETTINGS | |
| CALIBRATION | 111 |
| REC LAMP | 92 |

M MANUAL SETTINGS

(Items to adjust for scene condition)

See “Using menus” (p. 72) on the operation. The default settings are marked with ►.

SCENE SELECTION



You can record images effectively in various situations.

► AUTO

Records images in average image quality without the [SCENE SELECTION] function.

TWILIGHT* (☾)

Maintains the darkening atmosphere of the distant surroundings in twilight scenes.



SUNRISE&SUNSET* (☀)

Reproduces the atmosphere of scenes such as sunsets or sunrises.



FIREWORKS* (💣)

Takes spectacular shots of fireworks.



LANDSCAPE* (🏞️)

Shoots distant subjects clearly. This setting also prevents your camcorder from focusing on glass or metal mesh in windows between the camcorder and the subject.



PORTRAIT (Soft portrait)



Brings out the subject such as people or flowers while creating a soft background.



SPOTLIGHT** (🎤)

Prevents people's faces from appearing excessively white when subjects are lit by strong light.



BEACH** (🏖️)

Takes the vivid blue of the ocean or a lake.



SNOW** (❄️)

Takes bright pictures of a white landscape.



- * Adjusted to focus on subjects farther away only.
- ** Adjusted not to focus on subjects a short distance away.

🔔 Notes

- If you set [SCENE SELECTION], [WHITE BAL.] setting is canceled.

WHITE BAL. (White balance)



You can adjust the color balance to the brightness of the recording environment.



► AUTO

The white balance is adjusted automatically.

OUTDOOR (🌞)

The white balance is appropriately adjusted for the following recording conditions:

- Outdoors
- Night views, neon signs and fireworks
- Sunrise or sunset
- Under daylight fluorescent lamps

INDOOR (☞)

The white balance is appropriately adjusted for the following recording conditions:

- Indoors
- At party scenes or studios where the lighting conditions change quickly
- Under video lamps in a studio, or under sodium lamps or incandescent-like color lamps

ONE PUSH (☞)

The white balance will be adjusted according to the ambient light.

- ① Touch [ONE PUSH].
- ② Frame a white object such as a piece of paper, to fill the screen under the same lighting conditions as you will shoot the subject.
- ③ Touch [☞].
☞ flashes quickly. When the white balance has been adjusted and stored in the memory, the indicator stops flashing.

⚡ Notes

- Set [WHITE BAL.] to [AUTO] or adjust the color in [ONE PUSH] under white or cool white fluorescent lamps.
- When you select [ONE PUSH], keep framing white objects while ☞ is flashing quickly.
- ☞ flashes slowly if [ONE PUSH] could not be set.
- When [ONE PUSH] was selected, if ☞ keeps flashing after touching [OK], set [WHITE BAL.] to [AUTO].
- If you set [WHITE BAL.], [SCENE SELECTION] is set to [AUTO].

💡 Tips

- If you have changed the battery pack while [AUTO] was selected, or taken your camcorder outdoors after inside use (or vice versa), aim your camcorder at a nearby white object for about 10 seconds for better color balance adjustment.
- When the white balance has been set with [ONE PUSH], if the lighting conditions changed by bringing your camcorder outdoors

from inside the house, or vice versa, you need to redo the [ONE PUSH] procedure to readjust the white balance.

SPOT MTR/FCS (Spot meter/focus)



You can adjust the brightness and focus for the selected subject simultaneously.

This function enables you to use [SPOT METER] (p. 78) and [SPOT FOCUS] (p. 79) at the same time.

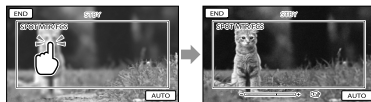

Touch the subject in the frame of which you want to adjust the brightness and focus.

To adjust the brightness and focus automatically, touch [AUTO].

⚡ Notes

- [EXPOSURE] and [FOCUS] are automatically set to [MANUAL].

SPOT METER (Flexible spot meter)



You can adjust and fix the exposure to the subject, so that it is recorded in suitable brightness even when there is strong contrast between the subject and the background, such as subjects in the spotlight on stage.

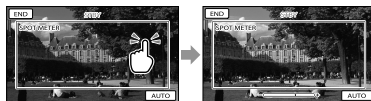

Touch the subject in the frame of which you want to adjust the exposure.

To return the setting to automatic exposure, touch [AUTO].

Notes

- [EXPOSURE] is automatically set to [MANUAL].

SPOT FOCUS



You can select and adjust the focal point to aim it at a subject not located at the center of the screen.



Touch the subject in the frame of which you want to adjust the focus.

To adjust the focus automatically, touch [AUTO].

Notes

- [FOCUS] is automatically set to [MANUAL].

EXPOSURE



You can fix the brightness of a picture manually. Adjust the brightness when the subject is too bright or too dark.

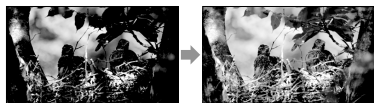

Touch **-** / **+** to adjust the brightness. To adjust the exposure automatically, touch [AUTO].

Tips

- You can also adjust the setting manually by using the RING (p. 31).

FOCUS



You can adjust the focus manually. You can select this function also when you want to focus on a certain subject intentionally.



Touch **▲** (nearby subject) / **▲** (distant subject) to adjust the focus.

To adjust the focus automatically, touch [AUTO].

Notes

- When you set [FOCUS] to [MANUAL], appears.
- The minimum possible distance between camcorder and subject while maintaining sharp focus is about 1 cm (about 13/32 in.) for wide angle and about 80 cm (about 31 1/2 in.) for telephoto.

Tips

- appears when the focus cannot be adjusted any closer, and appears when the focus cannot be adjusted farther away.
- It is easier to focus on the subject by moving the power zoom lever towards T (telephoto) to adjust the focus, then towards W (wide angle) to adjust the zoom for recording. When you want to record a subject at close range, move the power zoom lever to W (wide angle), then adjust the focus.
- The focal distance information (distance at which the subject is focused on; used as a guide if it is dark and focus adjustment is difficult) appears for a few seconds in the following cases. (This information will not display correctly if a conversion lens (sold separately) is being used.)
 - When the focus mode is switched from automatic to manual
 - When you set focus manually
- You can also adjust the setting manually by using the RING (p. 31).

TELE MACRO



This is useful to shoot small subjects, such as flowers or insects. You can blur out backgrounds and the subject stands out clearer.

▶ OFF

Cancels TELE MACRO. (TELE MACRO is also canceled when you move the zoom lever to the W side.)

ON (T)

The zoom (p. 27) moves to the top of the T (telephoto) side automatically and allows recording subjects at a close distance down to about 25 cm (9 7/8 in.).



⚡ Notes

- When recording a distant subject, focusing may be difficult and can take some time.
- Adjust the focus manually ([FOCUS], p. 79) when it is hard to focus automatically.

AE SHIFT



You can adjust the exposure using **[-]** (dark)/**[+]** (bright). **[AS]** and the setting value appear when you use [AE SHIFT].

💡 Tips

- Touch **[+]** if the subject is white or the backlight is bright, or touch **[-]** if the subject is black or the light is dim.
- You can adjust the automatic exposure level to brighter or darker when [EXPOSURE] is set to [AUTO].
- You can also adjust the setting manually using the RING (p. 31).

WB SHIFT



You can adjust the white balance to the desired setting using **[-]** / **[+]**. **[WS]** and the setting value appear when you use [WB SHIFT].

💡 Tips

- When the white balance is set to a lower value, pictures appear bluish, and when set to a higher value, pictures appear reddish.
- You can also adjust the setting manually using the RING (p. 31).

SMTH SLW REC (Smooth slow rec)



Fast moving subjects and actions, which cannot be captured under the ordinary shooting conditions, can be shot in smooth moving slow-motion for about 3 seconds. Press START/STOP on the [SMTH SLW REC] screen.

An about-3-second movie is recorded as a 12-second-slow-motion movie. [Recording...] disappears, when recording is finished.

Touch **[↶]** to cancel the smooth slow recording.

To change the setting

Touch **[OPTION]**, then select the setting you want to change.

[TIMING]

Select the recording start point after START/STOP is pressed. The default setting is [3sec AFTER].

The point when START/STOP is pressed.

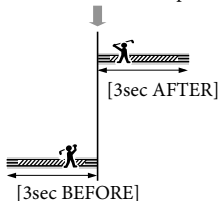

⚡ Notes

- You cannot record sound.
- Image quality is not as good as that of normal recording.

SHOOTING SET

(Items for customized shooting)

See “Using menus” (p. 72) on the operation. The default settings are marked with ►.



See page 28.



See page 29.



You can display the frame and check that the subject is horizontal or vertical. The frame is not recorded.

- OFF
Does not display the guide frame.
- ON
Displays the guide frame.



💡 Tips

- Positioning the subject at the cross point of the guide frame makes a balanced composition.
- The outer frame of [GUIDEFAME] shows the display area of a TV which is not compatible with full pixel display.
- When recording with the viewfinder, the outer frame of [GUIDEFAME] is not displayed.

STeadySHOT

You can compensate for camera shake. Set [STeadySHOT] to [OFF] () when using a tripod (sold separately), then the image becomes natural.

▶ ACTIVE

Provides a more powerful SteadyShot effect.

STANDARD

Provides the SteadyShot effect under relatively stable recording conditions.

OFF ()

The SteadyShot function is not used.

Notes

- If you change the setting of [STeadySHOT], the imaging field will also change accordingly.
- You can magnify images up to 12 times using optical zooming, unless [STeadySHOT] is set to [ACTIVE].

CONVERSION LENS

When using a conversion lens (sold separately), use this function to record using the optimum compensation for camera shake and focus for the lens.

▶ OFF

Select this when you do not use a conversion lens.

WIDE CONVERSION ()

Select this when you use a wide-conversion lens.

TELE CONVERSION ()

Select this when you use a tele-conversion lens.

LOW LUX

You can record bright color images, even in dim light.

▶ OFF

The LOW LUX function is not used.

ON ()

The LOW LUX function is used.

FACE DETECTION

Detects the faces of your subjects and adjusts the focus/color/exposure automatically. Also, it adjusts the image quality of face parts more finely, in the case of the high definition image quality (HD) movies.

▶ ON

Detects faces.

OFF ()

Does not detect faces.

Notes

- Faces may not be detected depending on recording conditions, subject conditions, and the setting of your camcorder.
- [FACE DETECTION] may not function properly depending on recording conditions. Set [FACE DETECTION] to [OFF] in this case.

Tips

- For better face detection performance, shoot the subject(s) under the following conditions:
 - Shoot in a sufficiently bright place
 - The subject(s) does not wear glasses, a hat or mask
 - The subject(s) faces directly towards the camera
- The detected faces are recorded in Face Index, however, some faces may not be. Also, there is a limit to the number of faces that can be recorded in Face Index. To play back from the Face Index, see page 36.

PRIORITY SETTING



Selects the priority subject for the face detection or the smile shutter.
Adjusts focus/color/exposure automatically for the selected faces.

▶ AUTO

Detects faces automatically.

CHILD PRIORITY

Detects with priority on a child's face.

ADULT PRIORITY

Detects with priority on an adult's face.

💡 Tips

- When you specify the priority subject by touching the detection frame on the LCD screen, the face with a double-lined frame has priority (p. 30).

SMILE DETECTION



The shutter is released when the camcorder detects a smile (Smile Shutter).

DUAL CAPTURE (📷)

Only during movie recording, the shutter is released automatically, when the camcorder detects a smile.

ALWAYS ON (📷)

The shutter is released when the camcorder detects a smile whenever the camcorder is in recording mode.

▶ OFF

Smiles are not detected, so photos are not recorded automatically.

🔋 Notes

- Smiles may not be detected depending on recording conditions, subject conditions, and the setting of your camcorder.
- When [DUAL CAPTURE] is selected, 📷 appears on the screen in movie recording standby, and 📷 changes into 📷 when movie recording starts.

SMILE SENSITIVITY



Sets the smile detection sensitivity using the Smile Shutter function.

HIGH

Detects even a slight smile.

▶ MEDIUM

Detects a normal smile.

LOW

Detects a big smile.

AUDIO REC SET



■ MICREF LEVEL (Microphone reference level)

You can select the microphone level for recording sound.

▶ NORMAL

Records various ambient sounds, converting them into the appropriate level.

LOW (🔊)

Records ambient sound faithfully. Select [LOW] when you want to record an exciting and powerful sound in a concert hall, etc. (This setting is not suitable for recording conversations.)

OTHER REC SET



■ 📷 DIGITAL ZOOM

You can select the maximum zoom level. Note that the image quality decreases when you use the digital zoom.



The zooming zone appears when you select [160x].

▶ OFF

Up to 17× zoom is performed.

160×

Up to 160× zoom is performed digitally.

⚡ Notes

- When [STEADYSHOT] is set to other than [ACTIVE], up to 12× zoom is performed optically.

■ AUTO BACK LIGHT

Your camcorder adjusts the exposure for backlit subjects automatically.

▶ ON

Adjusts the exposure for backlit subjects automatically.

OFF

Does not adjust the exposure for backlit subjects.

■ RING SETTING

You can select a menu items to assign to the RING. For details, see page 31.

■ X.V.COLOR

You can capture wider range of colors. Various colors such as the brilliant color of flowers and turquoise blue of the sea can be more faithfully reproduced. Refer to the instruction manuals of the TV.

▶ OFF

Records in ordinary color range.

ON ((COLOR))

Records in x.v.Color.

⚡ Notes

- Set [X.V.COLOR] to [ON] when the recorded movie will be played back on an x.v.Color-compliant TV.
- If the movie recorded with this function [ON] is played back on a non-x.v.Color-compliant TV,

the color may not be reproduced correctly.

- [X.V.COLOR] cannot be set to [ON]:
 - When recording standard definition image quality (STD) movies
 - While recording a movie

■ WIDE SELECT

When recording standard definition image quality (STD) movies, you can select the horizontal to vertical ratio according to the TV connected.

Refer also to the instruction manuals supplied with your TV.

▶ 16:9 WIDE

Records movies to the full screen on a 16:9 (wide) TV screen.

4:3 (4:3)

Records movies to the full screen on a 4:3 TV screen.

⚡ Notes

- Set [TV TYPE] correctly according to the TV connected for playback (p. 90).

PHOTO SETTINGS

(Items for recording photos)

See “Using menus” (p. 72) on the operation.
The default settings are marked with ▶.

SELF-TIMER

Press PHOTO to start the count down. A photo is recorded after about 10 seconds.

▶ OFF

Cancels the self-timer.

ON (☺)

Starts the self-timer recording. To cancel the recording, touch [RESET].

IMAGE SIZE

You can select a photo size to be shot.

▶ 7.1M (L7.1M)

Records photos clearly (3,072 × 2,304).

▶ 5.3M (L5.3M)

Records photos clearly in the 16:9 (wide) ratio (3,072 × 1,728).

▶ 1.9M (L1.9M)

Allows you to record more photos in relatively clear quality (1,600 × 1,200).



▶ VGA(0.3M) (LVGA)

Allows the maximum number of photos to be recorded (640 × 480).

Notes

- The selected image size is effective when the  (Photo) lamp is lit.
- See page 104 for the number of recordable photos.

STEADYSHOT

You can compensate for camera shake.
Set [ STEADYSHOT] to [OFF] () when using a tripod (sold separately), then the image becomes natural.

▶ ON

The SteadyShot function is used.

OFF ()

The SteadyShot function is not used.

FILE NO. (File number)

You can select the way to assign file number of photos.

▶ SERIES

Assigns file numbers of photos in sequence.

The file number becomes larger each time you record a photo.

Even if the memory card is replaced with another one, the file number is assigned in sequence.

RESET

Assigns file numbers in sequence, following the largest file number existing on the recording medium.

When the memory card is replaced with another one, the file number is assigned for each memory card.

▶ PLAYBACK

(Items for playback)

See “Using menus” (p. 72) on the operation.

VISUAL INDEX

See page 33.

VIEW IMAGES

■ DATE INDEX

See page 36.

■ FILM ROLL

See page 36.

■ FACE

See page 36.

PLAYLIST

See page 51.

HIGHLIGHT

See page 37.

SCENARIO

See page 38.

PLAYBACK SET

■ / SET

See page 28.

■ DATA CODE

During playback, your camcorder displays the information (Date/time, Camera data) recorded automatically at the time of recording.

▶ OFF

Data code is not displayed.

DATE/TIME

Displays the date and time.

CAMERA DATA

Displays camera setting data.

DATE/TIME

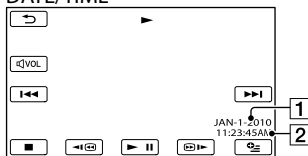

1 Date

2 Time

CAMERA DATA

Movie

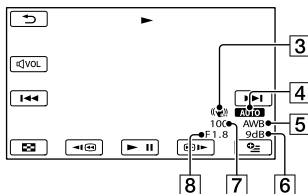

Photo

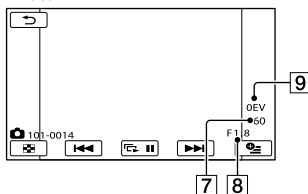

3 SteadyShot off

4 Brightness

5 White balance

6 Gain

7 Shutter speed

8 Aperture value

9 Exposure

Tips

- The data code is displayed on the TV screen if you connect your camcorder to a TV.
- Depending on the recording media condition, bars [---:---:---] appear.

EDIT

(Items for editing)

See “Using menus” (p. 72) on the operation.

DELETE 

See page 44.

 SCENARIO ERASE 

See page 38.

PROTECT 

See page 45.

 DIVIDE 

See page 46.

PHOTO CAPTURE 

See page 47.

MOVIE DUB 

See page 48.

PHOTO COPY 

See page 49.

PLAYLIST EDIT 

See page 50.



OTHERS

(Items for other settings)

See “Using menus” (p. 72) on the operation.

USB CONNECT



See page 69.

BATTERY INFO



You can check the estimated remaining capacity of the battery.

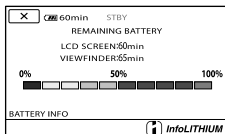

Notes

- If the remaining battery is 999 minutes or more, [>999min] is displayed on the LCD screen.

To close the battery information screen

Touch **✕**.



MANAGE MEDIA

(Items for recording media)

See “Using menus” (p. 72) on the operation.

MEDIA SETTINGS



See page 20.

MEDIA INFO



You can check the remaining recordable time for each recording mode of the recording media for movies and the approximate free and used media space of the recording media.

To turn off the display

Touch **✕**.

Notes

- Since there is a management file area, the used space is not displayed as 0 % even if you perform [MEDIA FORMAT] (p. 88).

Tips

- Only the information of the medium selected on [MOVIE MEDIA SET] (p. 20) is displayed. Change the medium setting if necessary.

MEDIA FORMAT



Formatting deletes all the movies and photos to recover recordable free space. Select the recording media to be formatted, touch [YES] → [YES] → **OK**.

Notes

- Connect your camcorder to the wall outlet (wall socket) using AC Adaptor supplied for this operation (p. 14).
- To avoid the loss of important images, you should save them before formatting the recording media.
- Protected movies and photos will also be deleted.
- While [Executing...] is displayed, do not operate the buttons on the camcorder, disconnect the AC Adaptor, or eject the

memory card from your camcorder (The access lamp is lit or flashing while formatting memory card.).



See page 97, 101.

To prevent data on the internal memory from being recovered

[EMPTY] allows you to write unintelligible data onto the internal memory of the camcorder. In this way it may become more difficult to recover any original data. When you dispose of or transfer the camcorder, it is recommended that you perform [EMPTY].

When the internal memory is selected on the [MEDIA FORMAT] screen, touch [EMPTY].

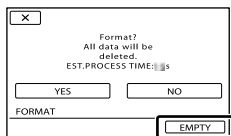

⚡ Notes

- Connect the AC Adaptor to the wall outlet (wall socket). You cannot perform [EMPTY] unless you connect the AC Adaptor to the wall outlet (wall socket).
- To avoid the loss of important images, they should be saved on a computer or other devices before performing [EMPTY].
- Disconnect all cables except the AC Adaptor. Do not disconnect the AC Adaptor during the operation.
- While deleting data, do not apply any vibrations or shocks to your camcorder.
- The actual performing time for deleting data is about 6 minutes.
- If you stop performing [EMPTY] while [Executing...] appears, be sure to complete the operation by performing [MEDIA FORMAT] or [EMPTY] when you use the camcorder next time.



GENERAL SET

(Other setup items)

See “Using menus” (p. 72) on the operation.
The default settings are marked with ▶.

SOUND/DISP SET

■ VOLUME

You can adjust the volume of playback sound by touching  / .

■ BEEP



ON

A melody sounds when you start/stop recording, or operate the touch panel.

▶ OFF

Cancels the melody.

■ LCD BRIGHT

You can adjust the brightness of the LCD screen by touching  / .

Tips

- This adjustment does not affect the recorded images in any way.

■ LCD BL LEVEL (LCD backlight level)

You can select the brightness of the LCD screen's backlight.

▶ NORMAL

Standard brightness.

BRIGHT

Brightens the LCD screen.



Notes

- When you connect your camcorder to the wall outlet (wall socket) using the supplied AC Adaptor, [BRIGHT] is automatically selected for the setting.
- When you select [BRIGHT], battery life is slightly reduced during recording.

Tips

- This adjustment does not affect the recorded images in any way.

■ LCD COLOR

You can adjust the color of the LCD screen by touching  / .

Tips

- This adjustment does not affect the recorded images in any way.

■ DISPLAY SET

You can set the duration of displaying the icons or indicators on the LCD screen.

AUTO1

Displays for about 3 seconds. The rec & zoom buttons on the LCD is displayed.

▶ AUTO2

Displays for about 3 seconds. The rec & zoom buttons on the LCD is not displayed.

ON

Always displays. The rec & zoom buttons on the LCD is not displayed.

Tips

- The icons or indicators are displayed in the following cases.
 - When you turn on your camcorder.
 - The LCD screen is touched (Except rec & zoom buttons on LCD).
 - When you switch your camcorder to the movie recording, photo recording, or playback modes.

OUTPUT SETTINGS

■ TV TYPE

You need to convert the signal depending on the TV connected when playing back movies and photos. The recorded movies and photos are played back as following illustrations.

▶ 16:9

Select this to view your movies on a 16:9 (wide) TV. The recorded movies and photos are played back as shown below.

Movies and photos recorded in 16:9 (wide) mode



Movies and photos recorded in 4:3 mode



4:3

Select this to view your movies and photos on a 4:3 standard TV. The recorded movies and photos are played back as shown below.

Movies and photos recorded in 16:9 (wide) mode



⚡ Notes

- Horizontal to vertical ratio of high definition image quality (HD) movies is 16:9.
- When you connect your camcorder to a TV compatible with the ID-1/ID-2 system, set [TV TYPE] to [16:9]. The TV switches to full mode automatically. Refer also to the instruction manuals supplied with your TV.

■ COMPONENT

Select [COMPONENT] when connecting your camcorder to a TV with the component input jack.

480i

Select this when connecting your camcorder to a TV with the component input jack.

▶ 1080i/480i

Select this when connecting your camcorder to a TV that has the component input jack and is capable of displaying the 1080i signal.

■ HDMI RESOLUTION

Select the output image resolution when connecting your camcorder to a TV with an HDMI cable (sold separately).

HD CONTENTS

Set the output image resolution recorded with high definition image quality (HD).

▶ AUTO

Normal setting (outputs the signal according to the TV automatically).

1080p

Outputs the 1080p signal.

1080i

Outputs the 1080i signal.

720p

Outputs the 720p signal.

480p

Outputs the 480p signal.

STD CONTENTS

Set the output image resolution recorded with standard definition image quality (STD).

▶ AUTO

Normal setting (outputs the signal according to the TV automatically).

480p

Outputs the 480p signal.

480i

Outputs the 480i signal.

■ DISP OUTPUT (Display output)

You can set where the screen displays are to be output.

▶ LCD PANEL

Shows displays such as the time code on the LCD screen/viewfinder.

V-OUT/PANEL

Shows displays such as the time code on the LCD screen/viewfinder, and on the TV screen.

CLOCK/🗓️ LANG

■ CLOCK SET

See page 16.

■ AREA SET

You can adjust a time difference without stopping the clock. Set your local area when using your camcorder in other time zones. Refer to the world time difference on page 107.

■ DST SET/SUMMERTIME

You can change this setting without stopping the clock. Set to [ON] to move the time forward 1 hour.

▶ OFF

Does not set the summertime.

ON

Sets the summertime.

■ 🗓️ LANGUAGE SET

You can select the language to be used on the LCD screen.

💡 Tips

- Your camcorder offers [ENG[SIMP]] (simplified English) for when you cannot find your native tongue among the options.

POWER SETTINGS

■ A.SHUT OFF (Auto shut off)

You can set your camcorder to turn off automatically when you do not operate your camcorder for more than about 30 minutes.

ON

The camcorder turns off automatically.

▶ OFF

The camcorder does not turn off automatically.

🔔 Notes

- [A.SHUT OFF] is effective only in the playback standby screen such as the VISUAL INDEX screen.

OTHER SETTINGS

■ CALIBRATION

See page 111.

■ REC LAMP (Recording lamp)

You can make the camera recording lamp on the front of your camcorder not to turn on.

▶ ON

The camera recording lamp lights up.

OFF

The camera recording lamp does not light up.

? Troubleshooting

If you run into any problems using your camcorder, follow the steps below.

① Check the list (p. 93 to 102), and inspect your camcorder.

② Disconnect the power source, attach the power source again after about 1 minute, and turn the camcorder on.

③ Press RESET (p. 119) using a pointed object, and turn the camcorder on. If you press RESET, all settings, including the clock setting, are reset.

④ Contact your Sony dealer or local authorized Sony service facility.

- Your camcorder may be required to initialize or change the current internal memory of your camcorder, depending on the problem. In the event of this, the data stored on the internal memory will be deleted. Be sure to save the data on the internal memory on other media (backup) before sending your camcorder for repair. We will not compensate you for any loss of internal memory data.
- During repair, we may check a minimum amount of data stored on the internal memory in order to investigate the problem. However, your Sony dealer will neither copy nor retain your data.

- Overall operations p. 93
- Batteries/power sources p. 94
- LCD screen/viewfinder p. 94
- Memory card p. 95
- Recording p. 95
- Playback p. 96
- Playing back images stored on memory card on other devices p. 97
- Editing movies/photos on your camcorder. p. 97
- Playback on the TV p. 97

- Dubbing/Connecting to other devices p. 98
- Connecting to a Computer p. 98
- Examples of functions that cannot be used simultaneously p. 98

Overall operations

The power does not turn on.

- Attach a charged battery pack to the camcorder (p. 13).
- The plug of the AC Adaptor has been disconnected from the wall outlet (wall socket). Connect it to the wall outlet (wall socket) (p. 13).

The camcorder does not operate even when the power is set to on.

- It takes a few seconds for your camcorder to be ready to shoot after the power is turned on. This is not a malfunction.
- Disconnect the AC Adaptor from the wall outlet (wall socket) or remove the battery pack, then reconnect it after about 1 minute. If the functions still do not work, press RESET (p. 119) using a pointed object. (If you press RESET, all settings, including the clock setting, are reset.)
- The temperature of your camcorder is extremely high. Turn off your camcorder and leave it for a while in a cool place.
- The temperature of your camcorder is extremely low. Leave your camcorder with the power of your camcorder on. Turn off your camcorder and take it to a warm place. Leave the camcorder there for a while, then turn on your camcorder.

The menu settings have changed automatically.

- The following menu items return to the default settings when you switch between movie recording and photo recording and playback modes.
 - [TELE MACRO]

- [ SELF-TIMER]

Your camcorder gets warm.

- Your camcorder may become warm during operation. This is not a malfunction.

Batteries/power sources

The power abruptly turns off.

- Use the AC Adaptor.
- If [A.SHUT OFF] is set to [ON], after about 30 minutes of displaying an index in playback mode and no camcorder operation, the camcorder will automatically turn off (A.SHUT OFF). Change the setting of [A.SHUT OFF] (p. 92), or turn on the power again.
- Charge the battery pack (p. 13).

The CHG (charge) lamp does not light while the battery pack is being charged.

- Slide the POWER switch to OFF (CHG) (p. 13).
- Attach the battery pack to the camcorder correctly (p. 13).
- Connect the power cord (mains lead) to the wall outlet (wall socket) properly.
- The battery charge is completed (p. 13).

The CHG (charge) lamp flashes while the battery pack is being charged.

- If the temperature of the battery pack is too high or too low, you may not be able to charge it (p. 109).
- Attach the battery pack to the camcorder correctly (p. 13). If the problem persists, disconnect the AC Adaptor from the wall outlet (wall socket) and contact your Sony dealer. The battery pack may be damaged.

The remaining battery time indicator does not indicate the correct time.

- The ambient temperature is too high or too low. This is not a malfunction.
- The battery pack has not been charged enough. Fully charge the battery again. If the problem persists, replace the battery pack with a new one (p. 110).
- The indicated time may not be correct depending on the environment of use.

The battery pack is quickly discharged.

- The ambient temperature is too high or low. This is not a malfunction.
- The battery pack has not been charged enough. Fully charge the battery again. If the problem persists, replace the battery pack with a new one (p. 110).

LCD screen/viewfinder

Menu items are grayed out.

- You cannot select grayed items in the current recording/playback situation.
- There are some functions you cannot activate simultaneously (p. 98).

The buttons do not appear on the touch panel.

- Touch the LCD screen lightly.

The buttons on the touch panel do not work correctly or do not work at all.

- Adjust the touch panel ([CALIBRATION]) (p. 111).

The buttons on the touch panel quickly disappear.

- Set [DISPLAY SET] to [ON] (p. 90).

The image in the viewfinder is not clear.

- Move the viewfinder lens adjustment lever until the image appears clearly (p. 18).

The LCD screen is not turned on.

- Slide the LCD/EVF-EVF switch to LCD/EVF (p. 19).

Memory card

Operations using the memory card cannot be performed.

- If you use the memory card formatted on a computer, format it again on your camcorder (p. 88).

Images stored on the memory card cannot be deleted.

- The maximum number of images that you can delete on the index screen at one time is 100.
- You cannot delete the protected images.



The data file name is not indicated correctly or flashes.

- The file is damaged.
- The file format is not supported by your camcorder (p. 109).

Recording

Refer also to “Memory card” (p. 95).

Pressing START/STOP or PHOTO does not record images.

- The playback screen is displayed. Press MODE to turn on the  (Movie) or  (Photo) lamp (p. 23).
- Your camcorder is recording the image you have just shot on the recording media. You cannot make new recording during this period.
- The recording media is full. Delete

unnecessary images (p. 44).

- Total number of movie scenes or photos exceeds the recordable capacity of your camcorder (p. 103, 104). Delete unnecessary images (p. 44).
- The temperature of your camcorder is extremely high. Turn off your camcorder and leave it for a while in a cool place.
- The temperature of your camcorder is extremely low. Turn off your camcorder and take it to a warm place. Leave the camcorder there for a while, then turn on the camcorder.

Photos cannot be recorded.

- You cannot record photos together with [SMTH SLW REC].
- When [ REC MODE] is set to [HD FX], you cannot record photos while recording movies.

The access lamp remains lit or flashing even if recording was stopped.

- Your camcorder is recording the scene you have just shot on the memory card.

The imaging field looks different.

- The imaging field may look different depending on the condition of your camcorder. This is not a malfunction.

The actual recording time for movies is less than the expected recording time of the recording media.

- Depending on the recording conditions, the time available for recording may be shorter, for example when recording a fast moving object, etc. (p. 103).

The camcorder stops operating.

- The temperature of your camcorder is extremely high. Turn off your camcorder and leave it for a while in a cool place.
- The temperature of your camcorder is extremely low. Turn off your camcorder and take it to a warm place. Leave the camcorder

there for a while, then turn on the camcorder.

- If you keep applying vibration on the camcorder, recording may stop.

There is a time difference between the point when START/STOP is pressed and the point that the recording movie is started or stopped actually.

- On your camcorder, there may be a slight time difference between the point where you press START/STOP and the actual point that recording movie starts/stops. This is not a malfunction.





The horizontal to vertical ratio of the movie (16:9 (wide)/4:3) cannot be changed.

- The horizontal to vertical ratio of high definition image quality (HD) movies is 16:9 (wide).

The auto focus does not function.

- Set [FOCUS] to [AUTO] (p. 79).
- The recording conditions are not suitable for auto focus. Adjust the focus manually (p. 79).

SteadyShot does not function.

- Set [STEADYSHOT] to [ACTIVE] or [STANDARD], [STEADYSHOT] to [ON] (p. 82, 85).
- Even if [STEADYSHOT] is set to [ACTIVE] or [STANDARD], [STEADYSHOT] to [ON], your camcorder may not be able to compensate for excessive vibrations.

The subjects passing by the screen very fast appear crooked.

- This is called the focal plane phenomenon. This is not a malfunction. Because of the way the image device (CMOS sensor) reads out image signals, the subjects passing by the lens rapidly might appear crooked depending on the recording conditions.

Horizontal stripes appear on the images.

- This occurs when recording images under a fluorescent lamp, sodium lamp, or mercury lamp. This is not a malfunction.

Black bands appear when you record a TV screen or computer screen.

- Set [STEADYSHOT] to an option except for [ACTIVE] (p. 82).

[LCD BL LEVEL] cannot be adjusted.

- You cannot adjust [LCD BL LEVEL] when the power is supplied from the AC Adaptor.

Magnification changes when the recording mode is switched.

- You cannot use digital zoom when your camcorder is in the photo recording mode.

Sound is not recorded correctly.

- If you disconnect an external microphone, etc. during recording movies, sound may not be recorded correctly.
- Connect the microphone again in the same way as when you start recording movies.
- If you connect a microphone with a monaural plug, only the left channel sound is recorded.

Playback

Images cannot be played back.

- Select the type of recording media you want to play back (p. 20).
- Select the image quality of the movie you want to play back (p. 28).
- Images recorded on other devices may not be played back. This is not a malfunction.



Photos cannot be played back.

- Photos cannot be played back if you have modified files or folders, or have edited the data on a computer. (The file name flashes in that case.) This is not a malfunction.

 is indicated on an image on the VISUAL INDEX screen.

- This may appear on an image recorded on other devices, edited on a computer, etc.
- You removed the AC Adaptor or the battery pack while the recording media icon at the top right corner of the screen flashes, or before the access lamp is turned off after recording. This may damage your image data and  is displayed.

 is indicated on an image on the VISUAL INDEX screen.

- The image data base file may be damaged. Check the data base file by touching **MENU** (MENU) → [Show others] → [REPAIR IMG.DB F.] (under  [MANAGE MEDIA] category) → the recording medium. If it still appears, delete the image with  (p. 44).

No sound or only a quiet sound is heard during playback.

- Turn up the volume (p. 35).
- When you record sound with [MICREF LEVEL] (p. 83) set to [LOW], the recorded sound may be difficult to hear.
- Sounds cannot be recorded while shooting with [SMTH SLW REC].

Playing back images stored on memory card on other devices

Images cannot be played back or the memory card is not recognized.

- The playback device does not support playing back memory cards (p. 3).

Editing movies/photos on your camcorder

Unable to edit.

- Unable to edit because of the condition of the image.

Movies cannot be added in the Playlist.

- There is no free space in the recording media.
- You can add no more than 999 high definition image quality (HD) movies, or 99 standard definition image quality (STD) movies, to a Playlist. Erase unnecessary movies from the Playlist (p. 51).
- You cannot add photos in the Playlist.

A movie cannot be divided.

- A movie that is too short cannot be divided.
- A protected movie cannot be divided.

A photo cannot be captured from a movie.

- The recording media where you want to save photos is full.

Playback on the TV

Neither image nor sound is played on the connected TV.

- When you are using the component video cable, set [COMPONENT] according to the requirements of the connected device (p. 91).
- When you are using the component video cable, make sure the red and white plugs of the A/V connecting cable are connected (p. 40).
- Images are not output from the HDMI OUT jack, if copyright protection signals are recorded in the images.

Neither image nor sound is played back on the TV, projector, or AV amplifier connected with the HDMI cable.

- If you cannot view images or hear sound on the TV, projector, or AV amplifier connected with the HDMI cable, or flicker occurs, try disconnecting and connecting the HDMI cable, or turn on your camcorder again.

The top, bottom, right, and left edges of images are trimmed slightly on a connected TV.

- The LCD screen of your camcorder can display recording images across the entire screen (full pixel display). However, this may cause slight trimming of the top, bottom, right, and left edges of images when played back on a TV which is not compatible with full pixel display.
- It is recommended you record images using the outer frame of [GUIDEFAME] (p. 81) as a guide.

The image appears distorted on the 4:3 TV.

- This happens when viewing an image recorded in the 16:9 (wide) mode on a 4:3 TV. Set [TV TYPE] correctly (p. 90) and play back the image.

Black bands appear at the top and bottom of the screen of the 4:3 TV.

- This happens when viewing an image recorded in the 16:9 (wide) mode on a 4:3 TV. This is not a malfunction.

Dubbing/Connecting to other devices

Images are not dubbed correctly.

- You cannot dub images using the HDMI cable (sold separately).

- The A/V connecting cable is not connected properly. Make sure to connect the cable to the input jack of another device (p. 70).

Connecting to a Computer

“PMB” cannot be installed.

- Check the computer environment or installation procedure required to install “PMB”.

“PMB” does not work correctly.

- Quit “PMB” and restart your computer.

The camcorder is not recognized by the computer.

- Disconnect devices from the USB jack of the computer other than the keyboard, mouse, and your camcorder.
- Disconnect the USB cable from the computer and your camcorder, and restart the computer, then connect the computer and your camcorder again in the correct order.

Examples of functions that cannot be used simultaneously

The following list shows examples of unworkable combinations of functions and menu items.

| Cannot use | Because of following settings |
|-------------|-------------------------------|
| INTELLIGENT | [SMTH SLW REC] |
| AUTO | |

| Cannot use | Because of following settings |
|--|--|
| [FACE DETECTION] | [SMTH SLW REC], [ZOOM DIGITAL ZOOM], [SPOT MTR/FCS], [SPOT METER], [SPOT FOCUS], [EXPOSURE], [FOCUS], [TWILIGHT], [SUNRISE&SUNSET], [FIREWORKS], [LANDSCAPE], [SPOTLIGHT], [BEACH], [SNOW], [WHITE BAL.], [SELF-TIMER] |
| [PRIORITY SETTING]/ [SMILE DETECTION]/ [SMILE SENSITIVITY] | [SMTH SLW REC], [ZOOM DIGITAL ZOOM], [SPOT MTR/FCS], [SPOT METER], [SPOT FOCUS], [EXPOSURE], [FOCUS], [TWILIGHT], [SUNRISE&SUNSET], [FIREWORKS], [LANDSCAPE], [SPOTLIGHT], [BEACH], [SNOW], [WHITE BAL.], [SELF-TIMER] |
| [SCENE SELECTION] | [SMTH SLW REC], [LOW LUX], [TELE MACRO] |

Self-diagnosis display/Warning indicators

If indicators appear on the LCD screen or viewfinder, check the following. If the problem persists even after you have tried to fix a couple of times, contact your Sony dealer or local authorized Sony service facility. In this case, when you contact them, give them all the numbers of the error code beginning with C or E.

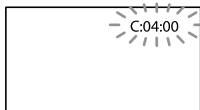

C:(or E): □□:□□ (Self-diagnosis display)

C:04:□□

- The battery pack is not an “InfoLITHIUM” battery pack (L series). Use an “InfoLITHIUM” battery pack (L series). (p. 109).
- Connect the DC plug of the AC Adaptor to the DC IN jack of your camcorder securely (p. 13).

C:06:□□

- The battery pack temperature is high. Change the battery pack or place it in a cool place.

C:13:□□ / C:32:□□

- Remove the power source. Reconnect it and operate your camcorder again.



E:□□:□□

- Follow the steps from ② on page 93.

 (Battery level warning)

Slow flashing

- The battery pack is nearly used up.
- Depending on the operating environment or battery conditions,  may flash, even if there are about 20 minutes remaining.

  (Warning indicator pertaining to battery pack temperature)

- The battery pack temperature is high. Change the battery pack or place it in a cool place.

 (High temperature warning)

Slow flashing

- The temperature of your camcorder is getting higher. Turn off your camcorder and leave it for a while in a cool place.

Fast flashing

- The temperature of your camcorder is extremely high. Turn off your camcorder and leave it for a while in a cool place.

 (Warning indicator pertaining to memory card)

Slow flashing

- Free spaces for recording images are running out. For the type of memory card you can use with your camcorder, see page 21.
- No memory card is inserted (p. 21).

Fast flashing

- There are not enough free spaces for recording images. After storing the images on other media (p. 64), delete unnecessary images, or format the memory card (p. 88).
- The image data base file may be damaged. Check the data base file by touching **MENU** (MENU) → [Show others] → [REPAIR IMG.DB F.] (under  [MANAGE MEDIA] category) → the recording medium.
- The memory card is damaged.

 (Warning indicators pertaining to memory card formatting)

- The memory card is damaged.
- The memory card is not formatted correctly (p. 88).

 (Warning indicator pertaining to incompatible memory card)

- Incompatible memory card is inserted (p. 21).

 (Warning indicator pertaining to the write-protect of the memory card)

- Access to the memory card was restricted on another device.
- You are using the memory card with the write-protect switch, and the switch is set to the LOCK position.

 (Warning indicator pertaining to camera-shake warning)

- The camcorder is unsteady, so camera-shake easily occurs. Hold the camcorder steady with both hands and record the image. However, note that the camera-shake warning indicator

does not disappear.

 (Warning indicator pertaining to photo recording)

- The recording media is full.
- Photos cannot be recorded during processing. Wait for a while, then record.
- When [ REC MODE] is set to [HD FX], you cannot record photos while recording movies.

 (Warning indicator pertaining to smile shutter)

- The smile shutter cannot be used with the current setting of the camcorder.

Tips

- When [BEEP] is set to [ON] and the some warning indicators appear, you hear beep sound (p. 90).

Description of warning messages

If messages appear on the screen, follow the instructions.

Recording media

 Internal memory format error.

- The internal memory of the camcorder is set differently from the default format. Performing [MEDIA FORMAT] (p. 88) may enable you to use your camcorder. This will delete all data in the internal memory.

Data error.

- An error occurred during reading or writing the internal memory of the camcorder.
- This may occur when you keep applying shock on the camcorder.
- Movies recorded on other devices may not be played back.

The Image Database File is damaged. Do you want to create a new file?

HD movie management information is damaged. Create new information?

- The management file is damaged. When you touch [YES], a new management file is created. The old recorded images on the media cannot be played back (Image files are not damaged). If you execute [REPAIR IMG. DB F.] after creating new information, playing back the old recorded images may become possible. If it does not work, copy the image using the supplied software.

There is no Image Database File. Movies cannot be recorded or played. Create a new file?

- You cannot record or play back movies because no movie management information exists. If you touch [YES], new management information is created and you can record or play back movies.
- You can record photos.

There is no HD movie management information. Create new information?

- You cannot record or play back movies because no high definition image quality (HD) movie management information exists. If you touch [YES], new management information is created and you can record or play back movies with high definition image quality (HD).
- You can record standard definition image quality (STD) movies or photos.

Inconsistencies found in Image Database File. Do you want to repair the Image Database File?

The Image Database File is damaged. Do you want to repair the Image Database File?

Inconsistencies found in Image Database File. Cannot record or play HD movies. Do you want to repair the Image Database File?

- The management file is damaged, and you cannot record movies or photos. Touch [YES] to repair.
- You can record photos on a memory card.

Buffer overflow

- A memory card on which recording and deleting has been repeated or formatted on other devices is used. Format the memory card on your camcorder after backing up the data to the hard disk of a computer, etc. (p. 88).
- Write performance of the memory card you are using is insufficient for the movie recording speed of your camcorder. Use a memory card recommended for your camcorder (p. 21).

Recovering data.

- Your camcorder tries to recover data automatically if the data writing was not performed properly.

Cannot recover data.

- Writing data onto the media of the camcorder has failed. Attempts were made to recover the data, but they were unsuccessful.

 Reinsert the memory card.

- Reinsert the memory card a few times. If even then the indicator flashes, the memory card could be damaged. Try with another memory card.

 This memory card is not formatted correctly.

- Format the memory card (p. 88). Note that if you format the memory card, all the recorded movies and photos are deleted.

 Still picture folder is full. Cannot record still pictures.

- You cannot create folders exceeding 999MSDCF. You cannot create or delete created folders using your camcorder.
- Format the memory card (p. 88), or delete folders using your computer.

This memory card may not be able to record or play movies.

- Use a memory card recommended for your camcorder (p. 21).

This memory card may not be able to record or play images correctly.

- Use a memory card recommended for your camcorder (p. 21).

Do not eject the memory card during writing. Data may be damaged.

- Reinsert the memory card, and follow the instructions on the LCD screen.
-

- Copying photos
 - Editing the Playlist of high definition image quality (HD) movies
-

Data protected.

- You tried to delete protected data. Release the protection of the data.
-

Other

No further selection is possible.

- You can add no more than 999 high definition image quality (HD) movies, or 99 standard definition image quality (STD) movies, to a Playlist.
- You can select only 100 images at one time for:
 - Deleting movies/photos
 - Protecting movies/photos, or releasing the protection
 - Dubbing movies

Recording time of movies/number of recordable photos

“HD” stands for high definition image quality, and “STD” stands for standard image quality.

Expected time of recording and playback with each battery pack

Recording time

Approximate time available when you use a fully charged battery pack.

(unit: minute)

| Battery pack | Continuous recording time | | Typical recording time | |
|--------------------|---------------------------|------|------------------------|-----|
| | HD | STD | HD | STD |
| NP-F570 (supplied) | 260 | 350 | 135 | 185 |
| NP-F770 | 540 | 720 | 285 | 380 |
| NP-F970 | 805 | 1080 | 425 | 570 |

- Each recording time is measured in the following [RECORD MODE] settings.
HD: HD FH
STD: HQ
- Typical recording time shows the time when you repeat recording start/stop, switching recording/playback, and zooming.
- Times measured when using the camcorder at 25 °C (77 °F). 10 °C to 30 °C (50 °F to 86 °F) is recommended.
- The recording and playback time will be shorter when you use your camcorder in low temperatures.
- The recording and playback time will be shorter depending on the conditions under which you use your camcorder.

Playing time

Approximate time available when you use a fully charged battery pack.

(unit: minute)

| Battery pack | HD | STD |
|--------------------|------|------|
| Image quality | | |
| NP-F570 (supplied) | 420 | 540 |
| | 420 | 565 |
| NP-F770 | 850 | 1095 |
| | 850 | 1155 |
| NP-F970 | 1295 | 1660 |
| | 1295 | 1750 |

- Top: When the LCD turns on.
Bottom: Recording with the viewfinder while the LCD turns off.

Expected recording time of movies

Internal memory

High definition image quality (HD) in h (hour) and m (minute)

| Recording mode | Recording time |
|----------------|-----------------------|
| [HD FX] | 6 h 5 m (6 h 5 m) |
| [HD FH] | 7 h 55 m (7 h 55 m) |
| [HD HQ] | 15 h 50 m (11 h 25 m) |
| [HD LP] | 26 h 55 m (21 h 30 m) |

Standard definition image quality (STD) in h (hour) and m (minute)

| Recording mode | Recording time |
|----------------|-----------------------|
| [STD HQ] | 16 h 15 m (14 h 30 m) |

Notes

- The number in () is the minimum recordable time.

Tips

- You can record movies of a maximum of 3,999 scenes with high definition image quality (HD), and 9,999 scenes with standard definition image quality (STD).
- The maximum continuous recording time of movies is approximately 13 hours.
- Your camcorder uses the VBR (Variable Bit Rate) format to automatically adjust image quality to suit the recording scene. This technology causes fluctuations in the recording time of the media. Movies containing quickly moving and complex images are recorded at a higher bit-rate, and this reduces the overall recording time.

Memory card

High definition image quality (HD)

(unit: minute)

| | AVC HD 24M (FX) | AVC HD 17M (FH) | AVC HD 9M (HQ) | AVC HD 5M (LP) |
|------|--------------------|--------------------|-------------------|-------------------|
| 1GB | 5 (5) | 6 (6) | 10 (9) | 20 (15) |
| 2GB | 10 (10) | 10 (10) | 25 (20) | 45 (35) |
| 4GB | 20 (20) | 25 (25) | 55 (40) | 90 (75) |
| 8GB | 40 (40) | 55 (55) | 110 (80) | 190 (150) |
| 16GB | 85 (85) | 110 (110) | 220 (160) | 380 (305) |
| 32GB | 175 (175) | 225 (225) | 455 (325) | 770 (615) |

Standard definition image quality (STD)

(unit: minute)

| | STD 9M (HQ) |
|------|--------------|
| 1GB | 10 (10) |
| 2GB | 25 (25) |
| 4GB | 55 (50) |
| 8GB | 115 (100) |
| 16GB | 230 (205) |
| 32GB | 465 (415) |

Notes

- The recordable time may vary depending on the recording and subject conditions and [REC MODE] (p. 29).
- The number in () is the minimum recordable time.

Expected number of recordable photos

Internal memory

You can record the maximum 9,999 photos.

Memory card

| | 7.1M  |
|------|---|
| 1GB | 255 |
| 2GB | 520 |
| 4GB | 1000 |
| 8GB | 2050 |
| 16GB | 4100 |
| 32GB | 8300 |

- The selected image size is effective when the  (Photo) lamp is lit.
- The number of recordable photos of memory card shown is for the maximum image size of your camcorder. The actual number of

recordable photos is displayed on the LCD screen during recording (p. 117).

- The number of recordable photos of memory card may vary depending on the recording conditions.

Notes

- The unique pixel array of Sony's ClearVid and the image processing system allow still image resolution equivalent to the sizes described.

Tips

- The following list shows the bit-rate, pixels and aspect ratio of each recording mode (movie + audio, etc.).
 - High definition image quality (HD):
 - FX: Max. 24Mbps 1,920 pixels × 1,080 pixels/16:9
 - FH: Approx. 17Mbps (average) 1,920 pixels × 1,080 pixels/16:9
 - HQ: Approx. 9Mbps (average) 1,440 pixels × 1,080 pixels/16:9
 - LP: Approx. 5Mbps (average) 1,440 pixels × 1,080 pixels/16:9
 - Standard definition image quality (STD):
 - HQ: Approx. 9Mbps (average) 720 pixels × 480 pixels/16:9, 4:3
- The photo recording pixels and the aspect ratio.
 - Photo recording mode:
 - 3,072 dots × 2,304 dots/4:3
 - 3,072 dots × 1,728 dots/16:9
 - 1,600 dots × 1,200 dots/4:3
 - 640 dots × 480 dots/4:3
 - Dual recording:
 - 3,072 dots × 1,728 dots/16:9
 - 2,304 dots × 1,728 dots/4:3
 - Capturing a photo from a movie:
 - 1,920 dots × 1,080 dots/16:9
 - 640 dots × 360 dots/16:9
 - 640 dots × 480 dots/4:3

Using your camcorder abroad

Power supply

You can use your camcorder in any countries/regions using the AC Adaptor supplied with your camcorder within the AC 100 V to 240 V, 50 Hz/60 Hz range.

Viewing high definition image quality (HD) movies

In countries/regions where 1080/60i is supported, you can view the movies with the same high definition image quality (HD) as that of the recorded movies.

You need an NTSC-system-based and 1080/60i compatible TV (or monitor) with component and AUDIO/VIDEO input jacks. A component video cable or an HDMI cable (sold separately) must be connected.

Viewing standard definition image quality (STD) movies

To view standard definition image quality (STD) movies, you need a NTSC-system-based TV with AUDIO/VIDEO input jacks. An A/V connecting cable must be connected.

On TV color systems

Your camcorder is a NTSC-system-based camcorder. If you want to view the playback image on a TV, it must be a NTSC-system-based TV with an AUDIO/VIDEO input jack.

| System | Used in |
|--------|--|
| PAL | Australia, Austria, Belgium, China, Czech Republic, Denmark, Finland, Germany, Holland, Hong Kong, Hungary, Italy, Kuwait, Malaysia, New Zealand, Norway, Poland, Portugal, Singapore, Slovak Republic, Spain, Sweden, Switzerland, Thailand, United Kingdom, etc. |
| PAL-M | Brazil |
| PAL-N | Argentina, Paraguay, Uruguay |
| SECAM | Bulgaria, France, Guiana, Iran, Iraq, Monaco, Russia, Ukraine, etc. |

| System | Used in |
|--------|---|
| NTSC | Bahama Islands, Bolivia, Canada, Central America, Chile, Colombia, Ecuador, Guyana, Jamaica, Japan, Korea, Mexico, Peru, Surinam, Taiwan, the Philippines, the USA, Venezuela, etc. |

Setting to the local time

You can easily set the clock to the local time by setting a time difference when using your camcorder abroad. Touch **MENU** (MENU) → [Show others] → [CLOCK/🗨️LANG] (under 🗨️ [GENERAL SET] category) → [AREA SET] and [DST SET]/[SUMMERTIME] (p. 92).

World time difference

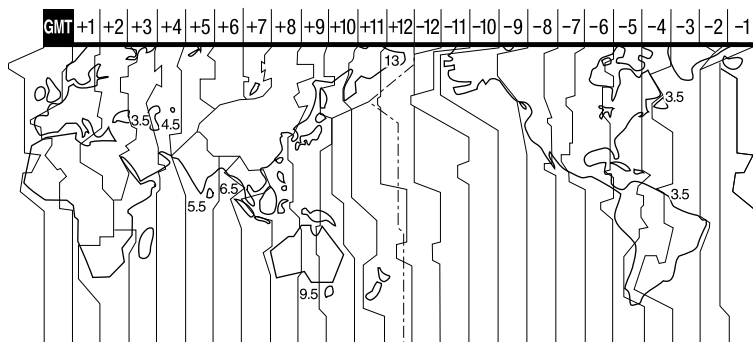

| Time-zone differences | Area setting |
|-----------------------|-------------------------------|
| GMT | Lisbon, London |
| +01:00 | Berlin, Paris |
| +02:00 | Helsinki, Cairo, Istanbul |
| +03:00 | Moscow, Nairobi |
| +03:30 | Tehran |
| +04:00 | Abu Dhabi, Baku |
| +04:30 | Kabul |
| +05:00 | Karachi, Islamabad |
| +05:30 | Calcutta, New Delhi |
| +06:00 | Almaty, Dhaka |
| +06:30 | Yangon |
| +07:00 | Bangkok, Jakarta |
| +08:00 | Hong Kong, Singapore, Beijing |
| +09:00 | Seoul, Tokyo |
| +09:30 | Adelaide, Darwin |
| +10:00 | Melbourne, Sydney |
| +11:00 | Solomon Is |

| Time-zone differences | Area setting |
|-----------------------|---------------------------------------|
| +12:00 | Fiji, Wellington, Eniwetok, Kwajalein |
| -11:00 | Samoa |
| -10:00 | Hawaii |
| -09:00 | Alaska |
| -08:00 | Los Angeles, Tijuana |
| -07:00 | Denver, Arizona |
| -06:00 | Chicago, Mexico City |
| -05:00 | New York, Bogota |
| -04:00 | Santiago |
| -03:30 | St.John's |
| -03:00 | Brasilia, Montevideo |
| -02:00 | Fernando de Noronha |
| -01:00 | Azores, Cape Verde Is. |

Maintenance and precautions

About the AVCHD format

What is the AVCHD format?

The AVCHD format is a high definition digital video camera format used to record a high definition (HD) signal of either the 1080i specification*¹ or the 720p specification*² using efficient data compression coding technology. The MPEG-4 AVC/H.264 format is adopted to compress video data, and the Dolby Digital or Linear PCM system is used to compress audio data.

The MPEG-4 AVC/H.264 format is capable of compressing images at higher efficiency than that of the conventional image compressing format. The MPEG-4 AVC/H.264 format enables a high definition video signal shot on a digital video camera recorder to be recorded on 8 cm DVD discs, hard disk drive, flash memory, memory card, etc.

Recording and playback on your camcorder

Based on the AVCHD format, your camcorder records with the high definition image quality (HD) mentioned below. In addition to high definition image quality (HD), your camcorder is capable of recording a standard definition (STD) signal in the conventional MPEG-2 format.

Video signal*³: MPEG-4 AVC/H.264 1920 × 1080/60i, 1440 × 1080/60i

Audio signal: Dolby Digital 2ch

Recording media:

Internal memory, memory card

*¹ 1080i specification

A high definition specification which utilizes 1,080 effective scanning lines and the interlace system.

*² 720p specification

A high definition specification which utilizes 720 effective scanning lines and the progressive system.

*³ Data recorded in AVCHD format other than the above mentioned cannot be played on your camcorder.

About the memory card

- A memory card formatted by a computer (Windows OS/Mac OS) does not have guaranteed compatibility with your camcorder.
- Data read/write speed may vary depending on the combination of the memory card and memory card compliant product you use.
- Damaged or lost data may occur in the following cases (the data will not be compensated for):
 - If you eject the memory card, or turn off your camcorder while your camcorder is reading or writing image files on the memory card (while the access lamp is lit or flashing)
 - If you use the memory card near magnets or magnetic fields
- It is recommended that you make a back-up of important data on the hard disk of a computer.
- Do not attach a label or the like on memory card or memory card adaptor.
- Do not touch, or allow metallic objects to come into contact with the terminals.
- Do not bend, drop or apply strong force to the memory card.
- Do not disassemble or modify the memory card.
- Do not let the memory card get wet.
- Keep the memory card out of the reach of small children. There is danger that a child might swallow it.
- Do not insert anything other than the compliant size of memory card into the memory card slot. Doing so may cause a malfunction.
- Do not use or keep the memory card in the following locations:
 - Places subject to extremely high temperature, such as a car parked outside in the summer
 - Places under direct sunlight
 - Places with extremely high humidity or subject to corrosive gases

On the memory card adaptor

- When using memory card with memory card compliant device inserting memory card into memory card adaptor, make sure the memory card is inserted facing in the correct direction. Note that improper use may cause a malfunction.

On image data compatibility

- Image data files recorded on memory card by your camcorder conform to the "Design rule for Camera File system" universal standard established by the JEITA (Japan Electronics and Information Technology Industries Association).
- On your camcorder, you cannot play back photos recorded on other devices (DCR-TRV900 or DSC-D700/D770) that do not conform to the universal standard. (These models are not sold in some regions.)
- If you cannot use memory cards that have been used with another device, format it with your camcorder (p. 88). Note that formatting erases all information on the memory card.
- You may not be able to play back images with your camcorder:
 - When playing back image data modified on your computer
 - When playing back image data recorded with other devices

About the "Memory Stick" media

| Types of "Memory Stick" media | Recording/Playback |
|---|--------------------|
| "Memory Stick Duo" media (with MagicGate) | — |
| "Memory Stick PRO Duo" (Mark2) media | ○ |
| "Memory Stick PRO-HG Duo" media | ○* |

- * This product does not support 8-bit parallel data transfer but it supports 4-bit parallel data transfer the same as with "Memory Stick PRO Duo" media.
- This product cannot record or play data that uses "MagicGate" technology. "MagicGate" is

a copyright protection technology that records and transfers the contents in an encrypted format.

About the "InfoLITHIUM" battery pack

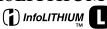
Your camcorder operates only with an "InfoLITHIUM" L series battery packs. "InfoLITHIUM" L series battery packs have the  mark.

What is an "InfoLITHIUM" battery pack?

- An "InfoLITHIUM" battery pack is a lithium-ion battery pack that has functions for communicating information related to operating conditions between your camcorder and an AC Adaptor/charger (sold separately).
- The "InfoLITHIUM" battery pack calculates the power consumption according to the operating conditions of your camcorder, and displays the remaining battery time in minutes.

To charge the battery pack

- Be sure to charge the battery pack before you start using your camcorder.
- We recommend charging the battery pack in an ambient temperature of between 10 °C to 30 °C (50 °F to 86 °F) until the CHG (charge) lamp turns off. If you charge the battery pack outside of this temperature range, you may not be able to charge it efficiently.

To use the battery pack effectively

- Battery pack performance decreases when the ambient temperature is 10 °C (50 °F) or below, and the length of time you can use the battery pack becomes shorter. In that case, do one of the following to use the battery pack for a longer time.
 - Put the battery pack in a pocket to warm it up, and install it on your camcorder right before you start taking shots.
 - Use a large capacity battery pack: NP-F770/ NP-F970 (sold separately).
- Frequent use of the LCD screen or a frequent

playback, fast forward or reverse operation wears out the battery pack faster. We recommend using a large capacity battery pack: NP-F770/NP-F970 (sold separately).

- Be sure to slide the POWER switch to OFF (CHG), when not recording or playing back on your camcorder. The battery pack is also consumed when your camcorder is in recording standby or playback pause.
- Have spare battery packs ready for 2 or 3 times the expected recording time, and make trial recordings before making the actual recording.
- Do not expose the battery pack to water. The battery pack is not water resistant.

About the remaining battery time indicator

- When the power goes off even though the remaining battery time indicator indicates that the battery pack has enough power to operate, charge the battery pack fully again. Remaining battery time will be indicated correctly. Note, however, that the battery indication will not be restored if it is used in high temperatures for a long time, or if left in a fully charged state, or when the battery pack is frequently used. Use the remaining battery time indication as a rough guide only.
- The  mark that indicates low battery flashes even if there are still 20 minutes of battery time remaining, depending on the operating conditions or ambient temperature.
- When the battery power remains 999 minutes or more, [999min] is displayed on the LCD screen.

About storage of the battery pack

- If the battery pack is not used for a long time, fully charge the battery pack and use it up on your camcorder once a year to maintain proper function. To store the battery pack, remove it from your camcorder and put it in a dry, cool place.

About battery life

- Battery capacity decreases over time and through repeated use. If decreased usage time

between charges becomes significant, it is probably time to replace it with a new one.

- Each battery's life is governed by storage, operating and environmental conditions.

About x.v.Color

- x.v.Color is a more familiar term for the xvYCC standard proposed by Sony, and is a trademark of Sony.
- xvYCC is an international standard for color space in video. This standard can express a wider color range than the currently used broadcast standard.

About handling of your camcorder

On use and care

- Do not use or store the camcorder and accessories in the following locations:
 - Anywhere extremely hot, cold or humid. Never leave them exposed to temperatures above 60 °C (140 °F), such as under direct sunlight, near heaters or in a car parked in the sun. They may malfunction or become deformed.
 - Near strong magnetic fields or mechanical vibration. The camcorder may malfunction.
 - Near strong radio waves or radiation. The camcorder may not be able to record properly.
 - Near AM receivers and video equipment. Noise may occur.
 - On a sandy beach or anywhere dusty. If sand or dust gets in your camcorder, it may malfunction. Sometimes this malfunction cannot be repaired.
 - Near windows or outdoors, where the LCD screen, the viewfinder or the lens may be exposed to direct sunlight. This damages the LCD screen and the viewfinder.
- Operate your camcorder on DC 7.2 V (battery pack) or DC 8.4 V (AC Adaptor).
- For DC or AC operation, use the accessories recommended in these operating instructions.
- Do not let your camcorder get wet, for example, from rain or sea water. If your camcorder gets wet, it may malfunction. Sometimes this

malfunction cannot be repaired.

- If any solid object or liquid gets inside the casing, unplug your camcorder and have it checked by a Sony dealer before operating it any further.
- Avoid rough handling, disassembling, modifying, physical shock, or impact such as hammering, dropping or stepping on the product. Be particularly careful of the lens.
- Keep the LCD screen closed when you are not using your camcorder.
- Do not wrap your camcorder with a towel, for example, and operate it. Doing so might cause heat to build up inside.
- When disconnecting the power cord (mains lead), pull it by the plug and not the cord.
- Do not damage the power cord (mains lead) such as by placing anything heavy on it.
- Do not use a deformed or damaged battery pack.
- Keep metal contacts clean.
- If the battery electrolytic liquid has leaked:
 - Consult your local authorized Sony service facility.
 - Wash off any liquid that may have contacted your skin.
 - If any liquid gets in your eyes, wash with plenty of water and consult a doctor.

When not using your camcorder for a long period

- To keep your camcorder in optimum state for a long time, turn it on and let it run by recording and playing back images about once a month.
- Use up the battery pack completely before storing it.

Moisture condensation

If your camcorder is brought directly from a cold place to a warm place, moisture may condense inside your camcorder. This may cause a malfunction to your camcorder.

- If moisture condensation has occurred
Leave your camcorder for about 1 hour without turning it on.
- Note on moisture condensation
Moisture may condense when you bring your

camcorder from a cold place into a warm place (or vice versa) or when you use your camcorder in a humid place as follows:

- You bring your camcorder from a ski slope into a place warmed up by a heating device.
 - You bring your camcorder from an air conditioned car or room into a hot place outside.
 - You use your camcorder after a squall or a shower.
 - You use your camcorder in a hot and humid place.
- How to prevent moisture condensation
When you bring your camcorder from a cold place into a warm place, put your camcorder in a plastic bag and seal it tightly. Remove the bag when the air temperature inside the plastic bag has reached the surrounding temperature (after about 1 hour).

LCD screen

- Do not exert excessive pressure on the LCD screen, as it may cause uneven color and other damage.
- If your camcorder is used in a cold place, a residual image may appear on the LCD screen. This is not a malfunction.
- While using your camcorder, the back of the LCD screen may heat up. This is not a malfunction.

To clean the LCD screen

- If fingerprints or dust make the LCD screen dirty, it is recommended that you use a soft cloth to clean it.

On adjustment of the touch panel (CALIBRATION)

The buttons on the touch panel may not work correctly. If this happens, follow the procedure below. It is recommended that you connect your camcorder to the wall outlet (wall socket) using the supplied AC Adaptor during the operation.

- ① **MENU** (MENU) → [Show others] → [OTHER SETTINGS] (under  [GENERAL SET] category) → [CALIBRATION].

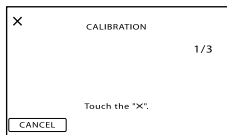

- ② Touch “X” displayed on the screen with the corner of memory card or the like 3 times. Touch [CANCEL] to cancel calibration.

Notes

- If you did not press the right spot, try the calibration again.
- Do not use a sharp-pointed object for calibration. Doing so may damage the LCD screen.
- You cannot calibrate the LCD screen if it is rotated, or closed with the screen facing out.

On handling the casing

- If the casing is soiled, clean the camcorder body with a soft cloth lightly moistened with water, and then wipe the casing with a dry soft cloth.
- Avoid the following to avoid damage to the finish:
 - Using chemicals such as thinner, benzene, alcohol, chemical cloths, repellent, insecticide and sunscreen
 - Handling the camcorder with above substances on your hands
 - Leaving the casing in contact with rubber or vinyl objects for a long period of time

About care and storage of the lens

- Wipe the surface of the lens clean with a soft cloth in the following instances:
 - When there are fingerprints on the lens surface
 - In hot or humid locations
 - When the lens is exposed to salty air such as at the seaside
- Store in a well-ventilated location subject to little dirt or dust.

- To prevent mold, periodically clean the lens as described above.

On charging the pre-installed rechargeable battery

Your camcorder has a pre-installed rechargeable battery to retain the date, time, and other settings even when the LCD screen is closed. The pre-installed rechargeable battery is always charged while your camcorder is connected to the wall outlet (wall socket) via the AC Adaptor or while the battery pack is attached. The rechargeable battery will be fully discharged in about 3 months if you do not use your camcorder at all. Use your camcorder after charging the pre-installed rechargeable battery.

However, even if the pre-installed rechargeable battery is not charged, the camcorder operation will not be affected as long as you are not recording the date.

How to charge the pre-installed rechargeable battery

Connect your camcorder to a wall outlet (wall socket) using the supplied AC Adaptor, and leave it with the POWER switch OFF (CHG) for more than 24 hours.

Note on disposal/transfer

Even if you delete all movies and still images, or perform [MEDIA FORMAT] (p. 88), data on the internal memory may not be completely erased. When you transfer the camcorder, it is recommended that you perform [EMPTY] (p. 89) to prevent the recovery of your data. Also, when you dispose of the camcorder, it is recommended that you destroy the actual body of the camcorder.

Note on disposal/transfer of the memory card

Even if you delete data in the memory card or format the memory card on your camcorder or a computer, you may not delete data from the memory card completely. When you give the memory card to somebody, it is recommended that you delete data completely using data deletion software on a computer. Also, when you

Specifications

dispose of the memory card, it is recommended that you destroy the actual body of the memory card.

System

Signal format: NTSC color, EIA standards HDTV 1080/60i specification

Movie recording format:

HD: MPEG-4 AVC/H.264 AVCHD format compatible
STD: MPEG-2 PS

Audio recording system:

Dolby Digital 2ch
Dolby Digital Stereo Creator

Photo file format

: DCF Ver.2.0 Compatible
: Exif Ver.2.21 Compatible
: MPF Baseline Compatible

Recording media (Movie/Photo)

Internal memory: 64 GB
“Memory Stick PRO Duo” media
SD memory card (Class 4 or faster)

When measuring media capacity, 1 GB equals 1 billion bytes, a portion of which is used for system management and/or application files. The capacity that a user can use is approximately 63.5 GB.

Viewfinder

Electronic viewfinder: color
Picture: 0.5 cm (0.2 type, aspect ratio 4:3)
Total dot number: 201 600 (Approx. 300 × 224 × 3 [RGB])

Image device: 4.5 mm (1/4 type) CMOS sensor

Recording pixels (photo, 4:3):
Max. 7.1 mega (3 072 pixels × 2 304 pixels)*1
Gross: Approx. 4 200 000 pixels
Effective (movie, 16:9):
Approx. 2 650 000 pixels*2
Effective (photo, 16:9):
Approx. 2 650 000 pixels
Effective (photo, 4:3):
Approx. 3 540 000 pixels

Lens: G lens

12× (Optical)*2, 17×*3, 160× (Digital)
Filter diameter: 37 mm (1 1/2 in.)
F1.8 ~ F3.4
Focal length:
f=2.9 mm ~ 34.8 mm (1/8 in. ~ 1 3/8 in.)
When converted to a 35 mm still camera
For movies*2: 29.8 mm ~ 357.6 mm (1 3/16 in. ~ 14 1/8 in.) (16:9)
For photos: 27.4 mm ~ 328.8 mm (1 1/8 in. ~ 13 in.) (4:3)

Color temperature: [AUTO], [ONE PUSH], [INDOOR] (3 200 K), [OUTDOOR] (5 800 K)

Minimum illumination

11 lx (lux) (in default setting, shutter speed 1/60 second)

3 lx (lux) (LOW LUX is set to [ON], shutter speed 1/30 second)

*¹ The unique pixel array of Sony's ClearVid and the image processing system allow still image resolution equivalent to the sizes described.

*² [H-STEADYSHOT] is set to [STANDARD] or [OFF].

*³ [H-STEADYSHOT] is set to [ACTIVE].

Input/Output connectors

VIDEO OUT jack:

Pin jack

1 Vp-p, 75 Ω (ohms)

AUDIO OUT jack:

Pin jack

Audio signal: 327 mV (at load impedance 47 kΩ (kilohms)), Output impedance with less than 2.2 kΩ (kilohms)

COMPONENT OUT jack:

Y: 1 Vp-p, 75 Ω (ohms)

PB/PR, CB/CR: ± 350 mV, 75 Ω (ohms)

REMOTE jack:

Stereo mini-minijack (Ø 2.5 mm)

HDMI OUT jack: HDMI connector

Headphone jack:

Stereo minijack (Ø 3.5 mm)

MIC jack:

Stereo minijack (Ø 3.5 mm)

USB jack: mini-AB (output only)

LCD screen

Picture: 6.7 cm (2.7 type, aspect ratio 16:9)

Total number of pixels: 230 400 (960 × 240)

General

Power requirements: DC 7.2 V (battery pack) DC 8.4 V (AC Adaptor)

Average power consumption: During camera recording, using viewfinder or LCD screen at normal brightness:

HD: 3.6 W STD: 2.7 W

Operating temperature: 0 °C to 40 °C (32 °F to 104 °F)

Storage temperature: -20 °C to +60 °C (-4 °F to +140 °F)

Dimensions (approx.):

255 mm × 232 mm × 456 mm (10 1/8 in.

× 9 1/4 in. × 18 in.) (w/h/d) including the

projecting parts, lens hood and eyecup
255 mm × 234 mm × 464 mm (10 1/8 in. × 9 1/4 in. × 18 3/8 in.)

(w/h/d) including the projecting parts, battery pack (NP-F570), lens hood, memory card, eyecup and microphone (ECM-PS1)

Mass (approx.)

2.7 kg (5 lb 15 oz) including the lens hood and eyecup

2.9 kg (6 lb 6 oz) including the battery pack (NP-F570), lens hood, memory card, eyecup and microphone (ECM-PS1)

AC Adaptor AC-L100C

Power requirements: AC 100 V - 240 V, 50 Hz/60 Hz

Current consumption: 0.35 A - 0.18 A

Power consumption: 18 W

Output voltage: DC 8.4 V*

Operating temperature: 0 °C to 40 °C (32 °F to 104 °F)

Storage temperature: -20 °C to +60 °C (-4 °F to +140 °F)

Dimensions (approx.): 48 mm × 29 mm × 81 mm (1 15/16 in. × 1 3/16 in. × 3 1/4 in.) (w/h/d) excluding the projecting parts

Mass (approx.): 170 g (6.0 oz) excluding the power cord (mains lead)

* See the label on the AC Adaptor for other specifications.

Rechargeable battery pack NP-F570

Maximum output voltage: DC 8.4 V

Output voltage: DC 7.2 V

Maximum charge voltage: DC 8.4 V

Maximum charge current: 3.0 A

Capacity

Typical: 15.8 Wh (2 200 mAh)

Minimum: 15.0 Wh (2 100 mAh)

Type: Li-ion

Design and specifications of your camcorder and accessories are subject to change without notice.

- Manufactured under license from Dolby Laboratories.

On trademarks

- “AVCHD” and “AVCHD” logotype are trademarks of Panasonic Corporation and Sony Corporation.
- “Memory Stick,” , “Memory Stick Duo,” “**MEMORY STICK DUO**,” “Memory Stick PRO Duo,” “**MEMORY STICK PRO DUO**,” “Memory Stick PRO-HG Duo,” “**MEMORY STICK PRO-HG DUO**,” “MagicGate,” “**MAGICGATE**,” “MagicGate Memory Stick” and “MagicGate Memory Stick Duo” are trademarks or registered trademarks of Sony Corporation.
- “InfoLITHIUM” is a trademark of Sony Corporation.
- “x.v.Color” is a trademark of Sony Corporation.
- “BRAVIA” is a trademark of Sony Corporation.
- “DVDirect” is a trademark of Sony Corporation.
- “Blu-ray Disc” and the logo are trademarks.
- AND/Or and the double-D symbol are trademarks of Dolby Laboratories.
- HDMI, the HDMI logo and High-Definition Multimedia Interface are trademarks or registered trademarks of HDMI Licensing LLC.
- Microsoft, Windows, Windows Vista, and DirectX are either registered trademarks or trademarks of Microsoft Corporation in the United States and/or other countries.
- Macintosh and Mac OS are registered trademarks of Apple Inc. in the U.S. and other countries.
- Intel, Intel Core, and Pentium are trademarks or registered trademarks of Intel Corporation or its subsidiaries in the United States and other countries.
- “PlayStation” is a registered trademark of Sony Computer Entertainment Inc..
- Adobe, the Adobe logo, and Adobe Acrobat are either registered trademarks or trademarks of Adobe Systems Incorporated in the United States and/or other countries.
- SDXC and SDHC logo are trademarks of SD-3C, LLC.
- MultiMediaCard is a trademark of MultiMediaCard Association.

All other product names mentioned herein may be the trademarks or registered trademarks of their respective companies. Furthermore, TM and [®] are not mentioned in each case in this manual.

Notes on the License

ANY USE OF THIS PRODUCT OTHER THAN CONSUMER PERSONAL USE IN ANY MANNER THAT COMPLIES WITH THE MPEG-2 STANDARD FOR ENCODING VIDEO INFORMATION FOR PACKAGED MEDIA IS EXPRESSLY PROHIBITED WITHOUT A LICENSE UNDER APPLICABLE PATENTS IN THE MPEG-2 PATENT PORTFOLIO, WHICH LICENSE IS AVAILABLE FROM MPEG LA, L.L.C., 250 STEELE STREET, SUITE 300, DENVER, COLORADO 80206.

THIS PRODUCT IS LICENSED UNDER THE AVC PATENT PORTFOLIO LICENSE FOR THE PERSONAL AND NON-COMMERCIAL USE OF A CONSUMER TO

(i) ENCODE VIDEO IN COMPLIANCE WITH THE AVC STANDARD (“AVC VIDEO”) AND/OR

(ii) DECODE AVC VIDEO THAT WAS ENCODED BY A CONSUMER ENGAGED IN A PERSONAL AND

NON-COMMERCIAL ACTIVITY AND/OR WAS OBTAINED FROM A VIDEO PROVIDER LICENSED TO PROVIDE AVC VIDEO. NO LICENSE IS GRANTED OR SHALL BE IMPLIED FOR ANY OTHER USE.

ADDITIONAL INFORMATION MAY BE OBTAINED FROM MPEG LA, L.L.C. SEE <[HTTP://WWW.MPEGLA.COM](http://WWW.MPEGLA.COM)>

“C Library,” “Expat,” “zlib,” “libjpeg,” “dtoa,” and “pcre” software are provided in your camcorder.

We provide this software based on license agreements with their owners of copyright. Based on requests by the owners of copyright of these software applications, we have an obligation to inform you of the following. Please read the following sections.

Read “license1.pdf” in the “License” folder on the CD-ROM. You will find licenses (in English) of “C Library,” “Expat,” “zlib,” “libjpeg,” “dtoa,” and “pcre” software.

On GNU GPL/LGPL applied software

The software that is eligible for the following

GNU General Public License (hereinafter referred to as “GPL”) or GNU Lesser General Public License (hereinafter referred to as “LGPL”) are included in the camcorder.

This informs you that you have a right to have access to, modify, and redistribute source code for these software programs under the conditions of the supplied GPL/LGPL.

Source code is provided on the web. Use the following URL to download it. When downloading the source code, select DCR-SX20 as the model for your camcorder.

<http://www.sony.net/Products/Linux/>

We would prefer you do not contact us about the contents of source code.

Read “license2.pdf” in the “License” folder on the CD-ROM. You will find licenses (in English) of “GPL,” and “LGPL” software.

To view the PDF, Adobe Reader is needed. If it is not installed on your computer, you can download it from the Adobe Systems web page:

<http://www.adobe.com/>

Screen indicators

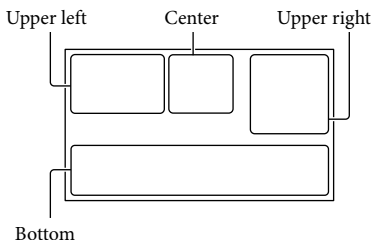

Upper left

| Indicator | Meaning |
|-----------|---------------------------|
| | MENU button (72) |
| | Self-timer recording (85) |
| | MICREF LEVEL low (83) |
| | WIDE SELECT (84) |
| | Remaining battery |
| | Recording folder |
| | Return button (72) |

Center

| Indicator | Meaning |
|--------------|-----------------------|
| [STBY]/[REC] | Recording status (24) |
| | Photo size (85) |
| | Slide show set (39) |
| | Warning (99) |
| | Playback mode (34) |

Upper right

| Indicator | Meaning |
|-----------|---|
| | Recording image quality (HD/STD) (28) and recording mode (FX/FH/HQ/LP) (29) |
| | Recording/playback/editing media (20) |
| 0:00:00 | Counter (hour:minute:second) |

| Indicator | Meaning |
|-----------|---|
| [00min] | Estimated recording remaining time |
| 9999 | Approximate number of recordable photos and recording media |
| | Playback folder (35) |
| 100/112 | Current playing movie or photo/Number of total recorded movies or photos (34) |

Bottom

| Indicator | Meaning |
|---------------|---|
| | [FACE DETECTION] set to [OFF] (82) |
| | SMILE DETECTION (83) |
| | LOW LUX (82) |
| | Manual focus (79) |
| | SCENE SELECTION (77) |
| | White balance (77) |
| AWB | White balance (86) |
| | SteadyShot off (82) |
| | SPOT MTR/FCS (78)/SPOT METER (78)/EXPOSURE (79) |
| AS | AE SHIFT (80) |
| WS | WB SHIFT (80) |
| AUTO | Automatic mode (32) |
| MANUAL | Image brightness manual setting mode (32) |
| AE A | IRIS priority mode (32) |
| AE S | SHUTTER SPEED priority mode (32) |
| | TELE MACRO (80) |
| (COLOR) | X.V.COLOR (84) |
| | Shutter speed (31) |
| F1.8 | IRIS (31) |
| | CONVERSION LENS (82) |

| Indicator | Meaning |
|-----------|----------------------------|
| | INTELLIGENT AUTO (27) |
| | OPTION button (74) |
| | VIEW IMAGES button (33) |
| | Slide show button (39) |
| | Data file name (35) |
| | Protected image (45) |
| | Index button (35) |

- Indicators and their positions are approximate and may differ from what you actually see.

Parts and controls

The numbers in () are reference pages.

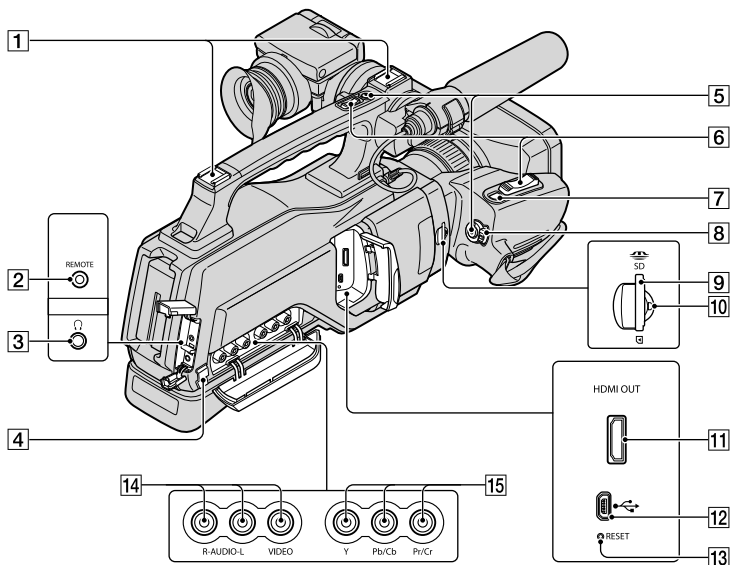

1 Cold shoe

2 REMOTE jack

The REMOTE jack is used for controlling the playback of video devices and peripherals connected to it.

3 (Headphone) jack

4 Cable holder

The cable holder is used for fixing the A/V connecting cable, etc.

5 REC START/STOP button (24)

6 Power zoom lever (27, 38)

7 PHOTO button (26)

8 POWER switch (16)

9 Memory card slot (22)

10 Access lamp (22)

11 HDMI OUT jack (Output only) (40)

- The available video signals are read, and the appropriate output format is selected and output automatically.

12 (USB) jack (mini-AB) (Output only) (55)

13 RESET button

Initializes all the settings, including the setting of the date and time.

14 A/V (audio/video) OUT jack (40, 71)

15 COMPONENT OUT jack (40)

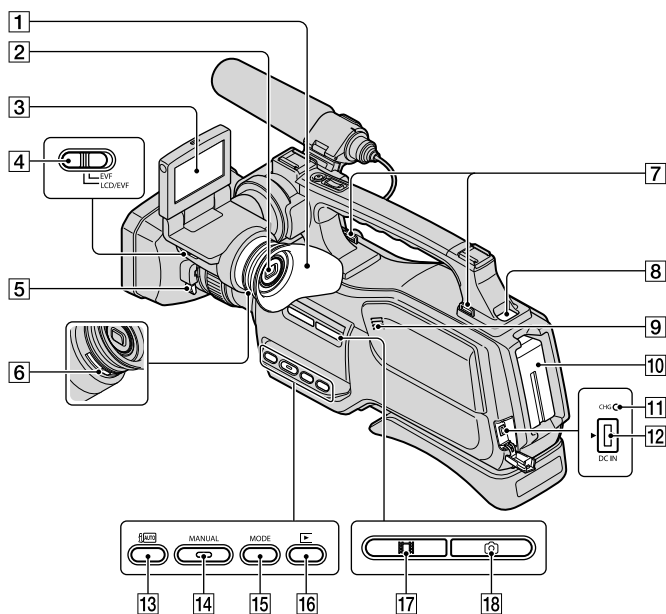

- 1 Eyecup
- 2 Viewfinder (18)
- 3 LCD screen/touch panel (2, 18)
- 4 LCD/EVF-EVF switch (19)
- 5 Lens hood release lever (12)
- 6 Viewfinder lens adjustment lever (18)
- 7 Hook for the Shoulder belt
Attach the Shoulder belt (sold separately).
- 8 BATT (battery) RELEASE button (14)
- 9 Speaker
- 10 Battery pack (13)
- 11 CHG (charge) lamp (13)
- 12 DC IN jack (13)
- 13 **i** **AUTO** (INTELLIGENT AUTO) button (27)
- 14 **MANUAL** button (31)
- 15 **MODE** button (23)
- 16 **VIEW IMAGES** button (33)
- 17 **Movie** lamp (23)
- 18 **Photo** lamp (23)

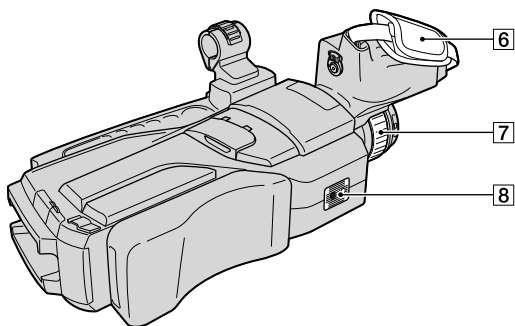
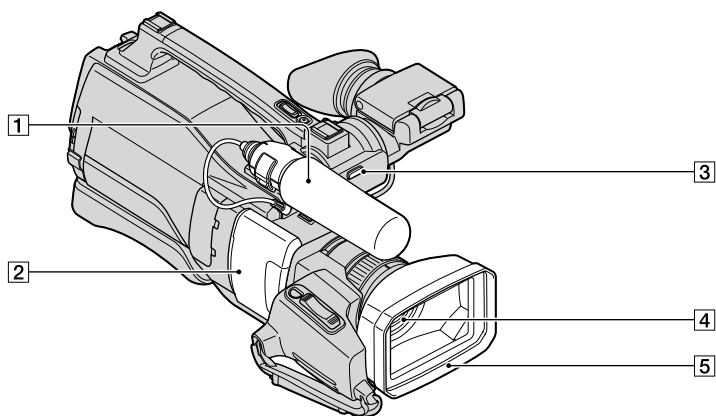

1 Microphone (10)

2 Slide cover (22)

3 REC lamp (Camera recording lamp)

- The REC lamp lights up in red during recording.
- The REC lamp flashes if the recording media or battery power is low.

4 Lens (G Lens)

5 Lens hood

6 Grip belt

7 RING (31)

8 Tripod receptacle

- Attach the tripod (sold separately: the length of the screw must be less than 5.5 mm (7/32 in.)) to the tripod receptacle using a tripod screw.

Index

Symbols

| | |
|-----------------|----|
| 1080i/480i..... | 91 |
| 16:9..... | 91 |
| 4:3..... | 91 |
| 480i..... | 91 |

A

| | |
|---------------------------|--------|
| A.SHUT OFF..... | 92 |
| A/V connecting cable..... | 40, 71 |
| Abroad..... | 106 |
| AE SHIFT..... | 80 |
| AREA SET..... | 92 |
| AUDIO REC SET..... | 83 |
| AUTO BACK LIGHT..... | 84 |
| AVCHD..... | 57 |
| AVCHD format..... | 108 |

B

| | |
|-------------------|----|
| BATTERY INFO..... | 88 |
| Battery pack..... | 13 |
| BEACH..... | 77 |
| BEEP..... | 90 |
| Blu-ray Disc..... | 62 |

C

| | |
|--|---------|
| CALIBRATION..... | 111 |
| CAMERA DATA..... | 86 |
| Capturing a photo from a movie..... | 47 |
| Capturing photos from a movie..... | 61 |
| Charging the battery pack..... | 13 |
| Charging the battery pack abroad..... | 15, 106 |
| CLOCK/LANG..... | 92 |
| CLOCK SET..... | 16 |
| COMPONENT..... | 91 |
| Computer..... | 53 |
| Computer system..... | 53 |
| CONVERSION LENS..... | 82 |
| Copy..... | 49 |
| Copying a disc..... | 63 |
| Creating a disc..... | 57, 66 |
| Creating a standard definition image quality (STD) disc..... | 63 |
| Creating AVCHD disc..... | 61 |

D

| | |
|-----------------------|--------|
| DATA CODE..... | 17, 86 |
| DATE/TIME..... | 17, 86 |
| Date Index..... | 36 |
| DELETE..... | 44 |
| DIGITAL ZOOM..... | 83 |
| Disc recorder..... | 70 |
| DISPLAY SET..... | 90 |
| DISP OUTPUT..... | 91 |
| DIVIDE..... | 46 |
| Dual Rec..... | 31 |
| Dubbing..... | 48 |
| DVDirect Express..... | 67 |
| DVD writer..... | 67, 69 |

E

| | |
|---------------------|----|
| EDIT..... | 44 |
| Editing movies..... | 60 |
| EMPTY..... | 89 |
| EXPOSURE..... | 79 |
| External media..... | 64 |

F

| | |
|----------------------|--------|
| FACE DETECTION..... | 82, 99 |
| Face Index..... | 36 |
| FH..... | 29 |
| FILE NO..... | 85 |
| Film Roll Index..... | 36 |
| FIREWORKS..... | 77 |
| FOCUS..... | 79 |
| Format..... | 88 |
| Fully charged..... | 13 |
| FX..... | 29 |

G

| | |
|------------------|----|
| GENERAL SET..... | 90 |
| GUIDEFAME..... | 81 |

H

| | |
|-------------------------|----|
| HD/STD SET..... | 28 |
| HDMI RESOLUTION..... | 91 |
| HIGHLIGHT..... | 37 |
| Highlight Playback..... | 37 |
| HQ..... | 29 |

I

| | |
|---------------------------------|--------|
| IMAGE SIZE..... | 85 |
| INDOOR..... | 78 |
| “InfoLITHIUM” battery pack..... | 109 |
| Install..... | 54 |
| INTELLIGENT AUTO..... | 27, 98 |

L

| | |
|-------------------|--------|
| LANDSCAPE..... | 77 |
| LANGUAGE SET..... | 17, 92 |
| LCD BL LEVEL..... | 90 |
| LCD BRIGHT..... | 90 |
| LCD COLOR..... | 90 |
| LOW LUX..... | 82 |
| LP..... | 29 |

M

| | |
|--------------------------------------|---------|
| Macintosh..... | 54 |
| Maintenance..... | 108 |
| MANAGE MEDIA..... | 20, 88 |
| MANUAL SETTINGS..... | 77 |
| MEDIA FORMAT..... | 88 |
| MEDIA INFO..... | 88 |
| MEDIA SETTINGS..... | 20 |
| Memory card..... | 21, 108 |
| “Memory Stick” media..... | 21 |
| “Memory Stick PRO-HG Duo” media..... | 21, 109 |
| “Memory Stick PRO Duo” media..... | 21, 109 |
| Menus..... | 72, 75 |
| MICREF LEVEL..... | 83 |
| Microphone..... | 10 |
| Moisture condensation..... | 111 |
| MOVIE DUB..... | 48 |
| MOVIE MEDIA SET..... | 20 |
| Movies..... | 24, 34 |
| MPEG-4 AVC/H.264..... | 108 |
| MY MENU..... | 73 |
| MY MENU SETTING..... | 73 |

N

| | |
|-----------|-----|
| NTSC..... | 106 |
|-----------|-----|

| | |
|---------------------------|----|
| O | |
| ONE PUSH | 78 |
| One Touch Disc Burn | 59 |
| OPTION MENU | 74 |
| Original | 48 |
| OTHER REC SET | 83 |
| OTHERS | 88 |
| OTHER SETTINGS | 92 |
| OUTDOOR | 77 |
| OUTPUT SETTINGS | 90 |

| | |
|---------------------------------------|--------|
| P | |
| PB zoom | 38 |
| PHOTO CAPTURE | 47 |
| PHOTO COPY | 49 |
| PHOTO MEDIA SET | 20 |
| Photos | 25, 35 |
| PHOTO SETTINGS | 85 |
| PLAYBACK | 86 |
| PLAYBACK SET | 86 |
| Playing | 33 |
| Playing AVCHD disc | 62 |
| Playlist | 50 |
| PLAYLIST EDIT | 50 |
| PMB (Picture Motion Browser) | 53, 56 |
| PMB Help | 56 |
| PORTRAIT | 77 |
| Power on | 16 |
| POWER SETTINGS | 92 |
| Precautions | 108 |
| PRIORITY SETTING | 83, 99 |
| PROTECT | 45 |

| | |
|---|-----|
| R | |
| REC LAMP | 92 |
| REC MODE | 29 |
| Recording | 23 |
| Recording and playback time | 103 |
| Recording media | 20 |
| Recording time of movies/ number of recordable photos | 103 |
| Repair | 93 |

| | |
|-----------------------|---------|
| REPAIR IMG.DB F | 97, 101 |
| RESET | 119 |
| RING SETTING | 31 |

| | |
|--|--------|
| S | |
| Saving images in external media | 64 |
| SCENARIO | 38 |
| SCENARIO ERASE | 38 |
| SCENE SELECTION | 77, 99 |
| Screen indicators | 117 |
| Self-diagnosis display/Warning indicators | 99 |
| SELF-TIMER | 85 |
| SHOOTING SET | 81 |
| Slide show | 39 |
| SLIDE SHOW SET | 39 |
| SMILE DETECTION | 83, 99 |
| SMILE SENSITIVITY | 83, 99 |
| Smile Shutter | 30 |
| SMTH SLW REC | 80 |
| SNOW | 77 |
| Software | 54 |
| SOUND/DISP SET | 90 |
| Specifications | 113 |
| SPOT FOCUS | 79 |
| SPOTLIGHT | 77 |
| SPOT METER | 78 |
| SPOT MTR/FCS | 78 |
| STEADYSHOT | 82, 85 |
| SUMMERTIME | 92 |
| SUNRISE&SUNSET | 77 |
| Supplied items | 2 |

| | |
|------------------------|-----|
| T | |
| TELE MACRO | 80 |
| Telephoto | 27 |
| Thumbnail | 44 |
| Troubleshooting | 93 |
| TV | 40 |
| TV color systems | 106 |
| TV TYPE | 90 |
| TWILIGHT | 77 |

| | |
|-------------------|------------|
| U | |
| USB cable | 67, 69 |
| USB CONNECT | 60, 67, 69 |

| | |
|--------------------|--------|
| V | |
| VBR | 103 |
| VIEW IMAGES | 33, 36 |
| VISUAL INDEX | 33 |
| Volume | 35, 90 |

| | |
|---------------------------------|-----|
| W | |
| Wall outlet (wall socket) | 13 |
| Warning messages | 100 |
| WB SHIFT | 80 |
| WHITE BAL | 77 |
| Wide angle | 27 |
| WIDE SELECT | 84 |
| Windows | 53 |

| | |
|-----------------|---------|
| X | |
| x.v.Color | 84, 110 |

| | |
|------------|--------|
| Z | |
| Zoom | 27, 38 |

<http://www.sony.net/>

Printed on 70% or more recycled paper using VOC
(Volatile Organic Compound)-free vegetable oil
based ink.

Printed in Japan



4263129110